



metafa  
holland bv

SLEUTEL EN ACCESSOIRES  
CATALOGUS



 **KEYLINE**

*Innovators by design | Since 1770*

A BIANCHI 1770 GROUP COMPANY



---

## INDEX

---

<b>TOPSLEUTELS.....</b>	<b>5</b>
<b>CILINDERSLEUTELS.....</b>	<b>7</b>
<b>FIETS- EN SCOOTERSLEUTELS.....</b>	<b>39</b>
<b>BANEN- EN BORINGSLEUTELS.....</b>	<b>45</b>
<b>AUTO - CARAVAN - TANKDOP- HEFTRUCK.....</b>	<b>51</b>
<b>STERSLEUTELS.....</b>	<b>55</b>
<b>ORGINELE SLEUTELS.....</b>	<b>57</b>
<b>TRANSPONDERS.....</b>	<b>61</b>
<b>TRANSPONDER SLEUTELS HOEFIJZERMODEL.....</b>	<b>67</b>
<b>PODSLEUTELS.....</b>	<b>77</b>
<b>HERLEIDINGEN KEYLINE - SILCA.....</b>	<b>85</b>
<b>HERLEIDINGEN SILCA - KEYLINE.....</b>	<b>91</b>
<b>FANCY SLEUTELS.....</b>	<b>101</b>
<b>LEGE AUTO BEHUIZINGEN.....</b>	<b>105</b>
<b>AUTOSLEUTELS EN AFSTANDBEDIENINGEN.....</b>	<b>143</b>
<b>AUTEL AFSTANDBEDIENINGEN.....</b>	<b>217</b>
<b>XHORSE AUTOSLEUTELS EN AFSTANDBEDIENINGEN.....</b>	<b>223</b>
<b>XHORSE SLEUTELBAARDEN.....</b>	<b>233</b>
<b>KEYLINE SLEUTELBAARDEN.....</b>	<b>241</b>
<b>AUTOSLEUTEL TOEBEHOREN.....</b>	<b>249</b>
<b>BAARDSLEUTELS.....</b>	<b>253</b>
<b>KLUISSLEUTELS.....</b>	<b>269</b>
<b>OPENINGSGEREEDSCHAP.....</b>	<b>275</b>
<b>ACCESSOIRES.....</b>	<b>283</b>
<b>RVS LETTERS EN SYMBOLEN.....</b>	<b>295</b>
<b>SMEERMIDDEL VOOR SLOTEN.....</b>	<b>301</b>
<b>SLOTEN O.A. EURO-LOCKS.....</b>	<b>303</b>
<b>BATTERIJEN.....</b>	<b>309</b>
<b>TADA.....</b>	<b>313</b>
<b>KEYLINE SLEUTELPRESENTATIE OPHANGSYSTEMEN.....</b>	<b>315</b>
<b>SLEUTELMACHINES.....</b>	<b>319</b>
<b>FREZEN EN ADAPTERS.....</b>	<b>333</b>







# TOPSLEUTELS

## TOPSLEUTELS

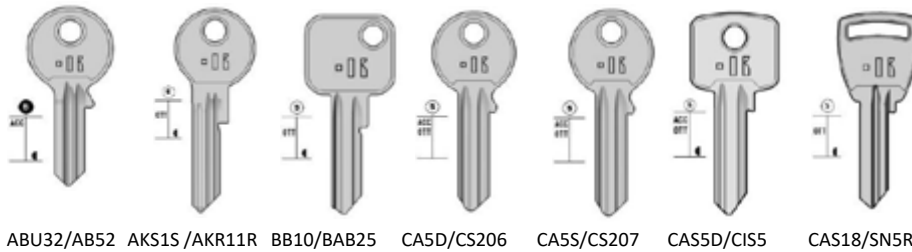

ABU32/AB52 AKS1S/AKR11R BB10/BAB25 CA5D/CS206 CA5S/CS207 CAS5D/CIS5 CAS18/SN5R

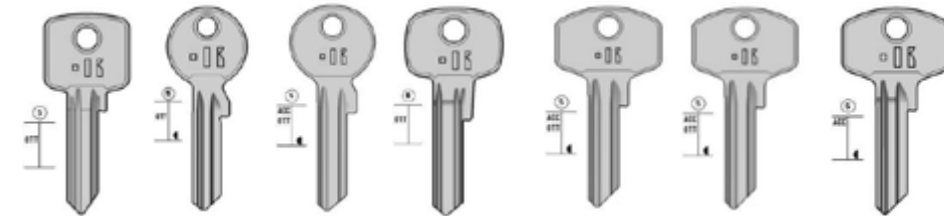

CAS30/CIS12X COR6D/CB6 CS2A/CE2 CS42/CE127 DO14/DM14 DO105S/DM151R DO220/DM119

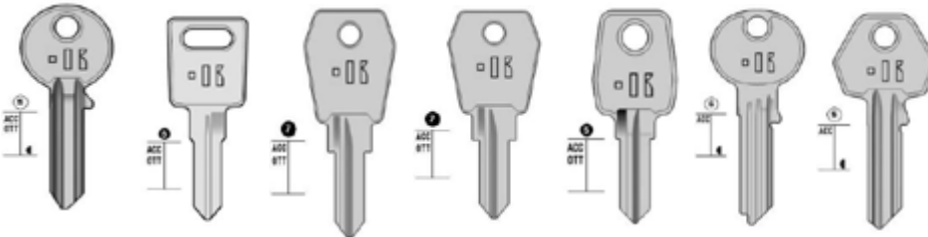

ISE5D/IE6 LAS3/LS11 LAS3S/LS11R LF1S/EU1R LF3S/EU5R LF23R/LF23R LI6S/LP57R LI21/LP21



LIT1S/LT2 LIT4/LT4 NF20S/NME1R TK10SL/TO120RX TOP1S/AB54 UN5D/UL050 UN5S/UL051



VC2/VAC2 VR5D/VI080 WI1-A/WK1X WI2/WK55 YE6D/YA31 YE51/YA1/YA226

STAAL

STAAL

ABU32-ST	LF3S-ST
AKS1S-ST	LF23R-ST
BB10-ST	LI6S-ST
CAS5D-ST	LI21-ST
CAS5-ST	LIT1S-ST
CAS5D-ST	LIT4-ST
CAS18-ST	NF20S-ST
CAS30-ST	TK10SL-ST
COR6D-ST	TOP1S-ST
CS2A-ST	UN5D-ST
CS42-ST	UN5S-ST
DO14-ST	VC2-ST
DO105S-ST	VR5D-ST
DO220-ST	WI1A-ST
ISE5D-ST	WI2-ST
LAS3-ST	YE6D-ST
LAS3S-ST	YE51-ST
LF1S-ST	

MESSING

MESSING

AKS1S-MS	LF1S-MS
BB10-MS	LF3S-MS
CAS5D-MS	LF23R-MS
CAS5-MS	LI6S-MS
CAS5D-MS	LI21-MS
CAS18-MS	LIT1S-MS
CAS30-MS	LIT4-MS
COR6D-MS	TK10SL-MS
CS2A-MS	TOP1S-MS
CS42-MS	UN5D-MS
DO14-MS	UN5S-MS
DO105S-MS	VC2-MS
DO220-MS	VR5D-MS
ISE5D-MS	WI2-MS
LAS3-MS	YE6D-MS
LAS3S-MS	YE51-MS



## CILINDERSLEUTELS

**CILINDERSLEUTELS**

**ABSA**



ABS3 ABS3S

**ABUS**



ABU52



ABU21



ABU39

ABS3	KEY1
ABS3S	KEY1R
ABU52	AB15
ABU21	AB76
ABU39	AB19

**ABUS**



ABU2



ABU17



ABU17S



ABU6

ABU2	AB12
ABU17	AB17
ABU17S	AB17R
ABU6	AB2
ABU18	AB18

ABU18

**ABUS**



ABU43 ABU43S



ABU22-T



ABU8



ABU8S



ABU1

ABU19-A  
 ABU1S

ABU43	AB43
ABU43S	AB43R
ABU22T	AB76
ABU8	AB3
ABU8S	AB3R
ABU1	AB1
ABU1S	ABU1R
ABU19-A	CS38

**CILINDERSLEUTELS**

**ABUS**

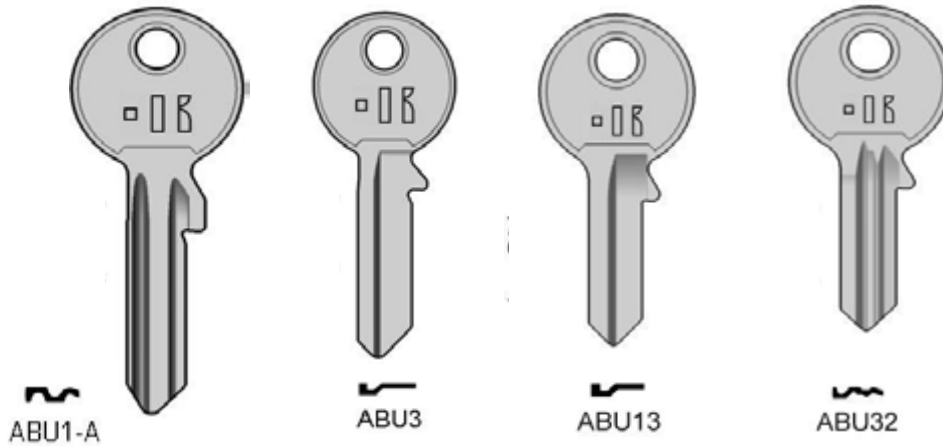

- |        |      |
|--------|------|
| ABU1-A | AB1X |
| ABU3   | AB14 |
| ABU13  | AB13 |
| ABU32  | AB52 |

TOPSLEUTEL:  
 ABU32-ST STAAL

abu32 IN VOORDEEL  
 VERPAKKING  
 VERKRIJGBAAR  
 STAAL

**ABUS**



- |        |      |
|--------|------|
| ABU53  | AB53 |
| ABU35S | AB54 |
| ABU36  | AB91 |
| ABU59S |      |
| ABU60S | AB86 |
| ABU61S | AB61 |

ABU59S=  
 UW SLEUTELSPECIALIST  
 ABU60S= FIXET

ABU61S= ENORM

**ABUS**

**ANKER**



- |           |        |
|-----------|--------|
| ABU89     | AB89   |
| ABU95     | AB895  |
| ABU96     | ABU96  |
| ABU163    | AB63   |
| AKS1S     | AKR11R |
| AKS2      | AKR2   |
| AKS16S    | AKR16R |
| ABU89=E60 |        |
| ABU95=E30 |        |

IN VOORDEEL  
 VERPAKKING  
 VERKRIJGBAAR  
 STAAL EN MESSING

TOPSLEUTEL  
 AKS1S-MS MESSING

**CILINDERSLEUTELS**

**ANKER**



 AKS4

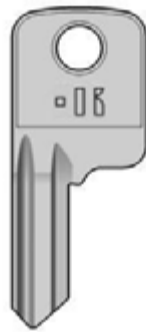

 AKS7



 AKS8

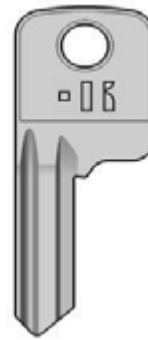

 AKS10

AKS4	AKR4
AKS7	AKR7
AKS8	AKR8
AKS10	AKR10

**ALPHA**

**ARMSTRONG**

**ASSA**



 ALP4

 ALP4S



 ARM1S



 AS20



 AS28N

ALP4	ALP4
ALP4S	ALP4R
ALP9	ALP9
ALP9S	ALP9R
ARM1S	ART1R
AS20	ASS31/40
AS28N	ASS2/38

**ASSA**

**BASI**

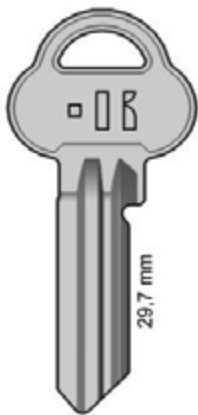

 NN  
AS29NN



 E  
AS34E

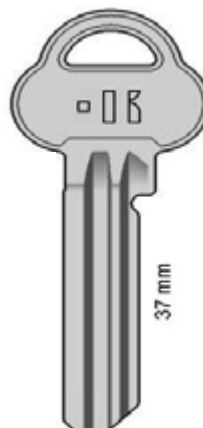



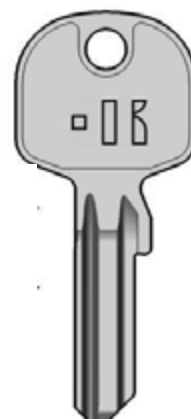









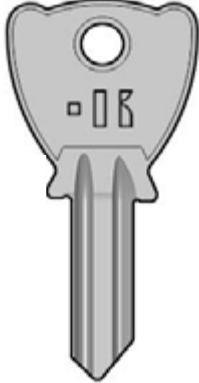
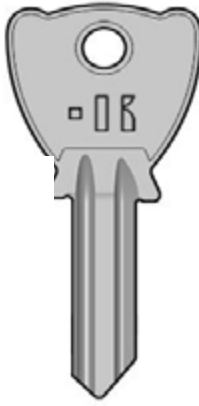







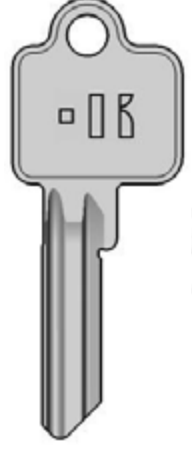



 HH  
AS37HH

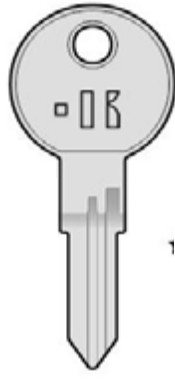

 BA1  **NEW** BA8S

AS29NN	ASS44/45
AS34E	ASS31/40
AS37HH	ASS52R/73I
BA1	BAI1
BA8S	

**CILINDERSLEUTELS**

BAB		BRICARD		BETA			
							
BB10 IN VOOREEL VERPAKKING VERKRIJGBAAR STAAL MESSING					BB10      BAB13/25 TOPSLEUTEL BB10-ST      STAAL BB10-MS      MESSING  BB10S      BAB13R  BD11S      BD6R  BE4D      BE200 BE5D      BE202		
							
BB10	BB10S	BD11S	BE4D	BE5D			
BKS			BMB				
							
					BK1      BK1 BK2S      BK26/SH3 BK15      BK15 BK12S      BK30 BK16      BK16 BMB3      BMB3		
							
BK1	BK2S	BK12S		BMB3			
BMB		KARWEI		BOMORRO		BRABANTIA	
							
						BMB5      BMB5  BMC1      MSF1  BO2      BO2  BRA2S      MAR1	
							
NEW BMB5	NEW BMC1	BO2	BRA2S				

**CILINDERSLEUTELS**

**BLAU**



BSC2



BT2

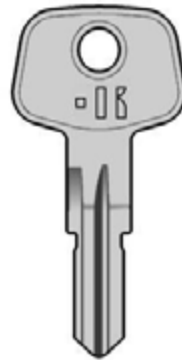

BT4



NEW BT5

BSC2	BSC2 -
BT2	BT2
BT4	BT4
BT5	BT5

**BURG**



BU1



BU2



BU3



BU3S



BU4



BU4S

BU1	BUR2
BU2	BUR1
BU3	BUR20
BU3S	BUR20R
BU4	BUR21
BU4S	BUR21R

**BURG**



BU5S



BU61



BU6

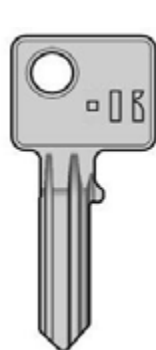

BU10

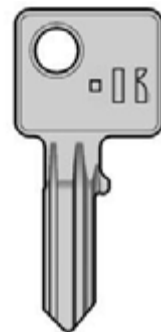

BU10S

BU5S	BUR24R
BU6	BUR34R
BU10	BUR29
BU10S	BUR29R
BU11	BUR62
BU61	BUR61R
BU61 HOOFDSLEUTEL	

BU11



**CILINDERSLEUTELS**

**BURG**



**BU16**



**BU23**



**BU23S**



**BU28S**

**BU31**

**BU31S**

BU16	BUR13
BU23	BUR23
BU23S	BUR23R
BU28S	BUR28R
BU31	BUR31
BU31S	BUR31R

**BURG**

**BUVA**

**CISA**



**NEW BU38**



**BUVA3**

BVA1 = KE4

BVA4 = KE7



**CA4D**



**CA3D**



**CA4PD**

BU38	BUR38
BUVA3	BVA3
BVA4	KE7 K.L.
BVA1	KE4 K.L.
CA4D	CS204
CA4PD	CS6
CA4PS	CS6R
CA3D	CS4

**CISA**



**CA5PD CA5PS**



**CA5D CA5S**

CA5D en CA5S  
 IN VOORDEEL  
 VERPAKKING  
 VERKRIJGBAAR  
 STAAL  
 MESSING



**CA13D**



**CA18 CA18S**

CA5PD	CS7
CA5PS	CS7R
CA5D	CS206
CA5S	CS207

**TOPSLEUTEL**

CA5D-ST	STAAL
CA5D-MS	MESSING
CA5S-ST	STAAL
CA5S-MS	MESSING
CA13D	CS13
CA18	CS32
CA18S	CS32R

**CILINDERSLEUTELS**

**CISA**



CA19S	CS33R
CA43	
CA50D	CS17
CA83	
CA85	CS85
CA21	CS38
CA40D	CS120
CA41D	CS119



**CAB**

**CAS-CISMA**



CAB1	CAB1
CAB2S	CAB2R
CAS2PD	CIS2
CAS3PD	CIS3



**CAS - CISMA**







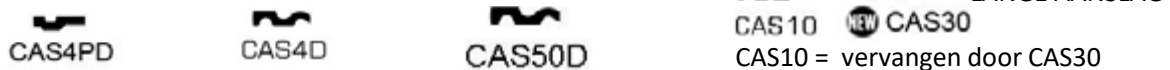





CAS4PD	CIS4
CAS4D	CIS6
CAS10	CIS12
CAS30	CS12X
TOPSLEUTEL	
CAS30-ST	STAAL
CAS30-MS	MESSING
CAS50D	NOXXA





CAS30 IN  
VOORDEEL  
VERPAKKING  
VERKRIJGBAAR  
STAAL  
MESSING

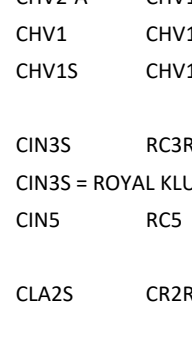

**CILINDERSLEUTELS**

CAS-CISMA	CAX	CEMA	CHUBB
 <p>CAS18 IN VOORDEEL VERPAKKING VERKRIJGBAAR STAAL MESSING</p> <p>CAS18</p>	 <p>CAX1S</p>	 <p>NEW CAX2S</p>	 <p>CEM1</p>
			 <p>CHU6</p>
			<p>CAS18 SN5R                  CAX1S CAX1R                  CAX2S CAX2R                  CEM1 CM2</p> <p>CHU6 CHU6</p> <p>TOPSLEUTEL                  CAS18-ST STAAL                  CAS18-MS MESSING</p>

CHAVO	CINA	CLAUSOR
 <p>NEW CHV</p>	 <p>NEW CHV1S</p>	 <p>CHV2-A</p>
	 <p>CIN3S</p>	 <p>NEW CIN5</p>
		 <p>CLA2S</p>
		<p>CHV2-A CHV1X                  CHV1 CHV1                  CHV1S CHV1R</p> <p>CIN3S RC3R                  CIN3S = ROYAL KLUISSEL                  CIN5 RC5</p> <p>CLA2S CR2R</p>

CORBIN			
 <p>COR6D IN VOORDEEL VERPAKKING VERKRIJGBAAR STAAL MESSING</p> <p>COR6D</p>	 <p>COR6S</p>	 <p>COR4PD</p>	 <p>COR5D</p>
			 <p>COR5PD</p>
			<p>COR6D CB6                  TOPSLEUTEL                  COR6D-ST STAAL                  COR6D-MS MESSING</p> <p>COR6S CB6R                  COR4PD CB4                  COR5D CB5                  COR5PD CB3</p>

## CILINDERSLEUTELS

### CORBIN

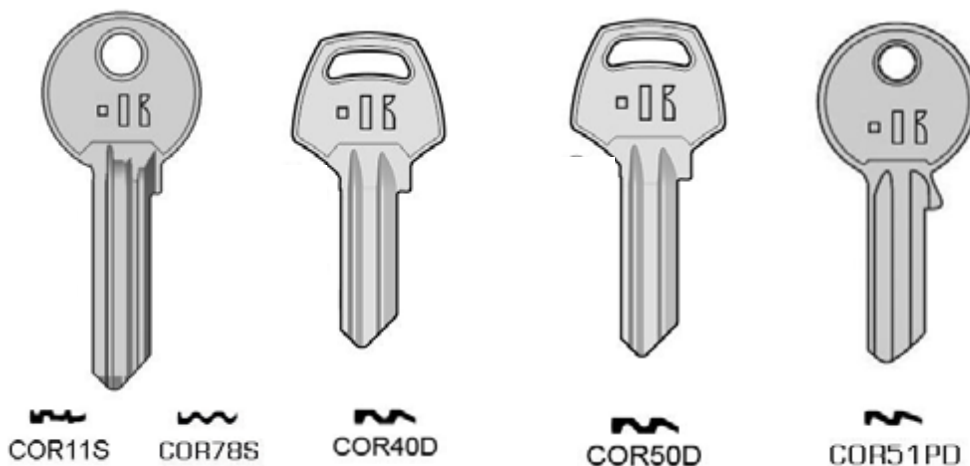

COR11S  
COR40D    CB2  
COR50D    CB1  
COR51PD    CB15  
COR78S    CB78R

### CORBIN

### CORONA

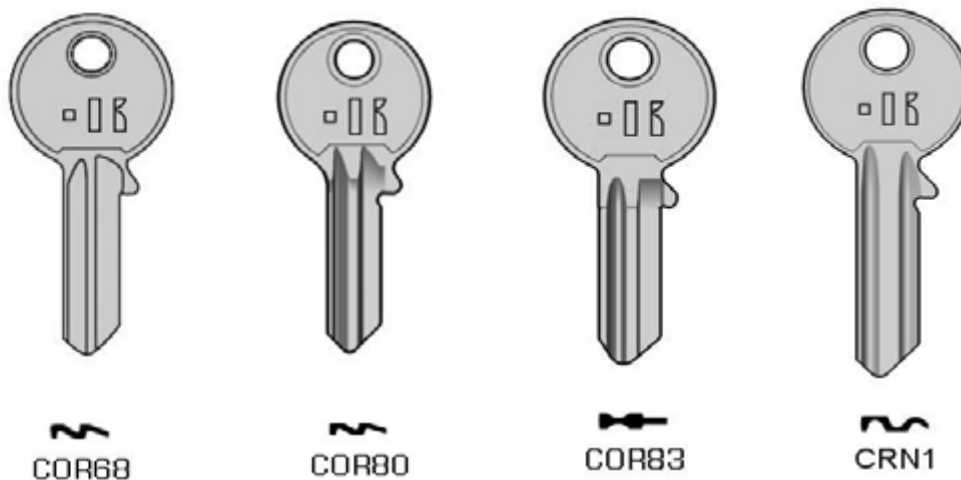

COR68    CB85  
COR80    CB80  
COR83    CB83  
CRN1    COR1

### CES

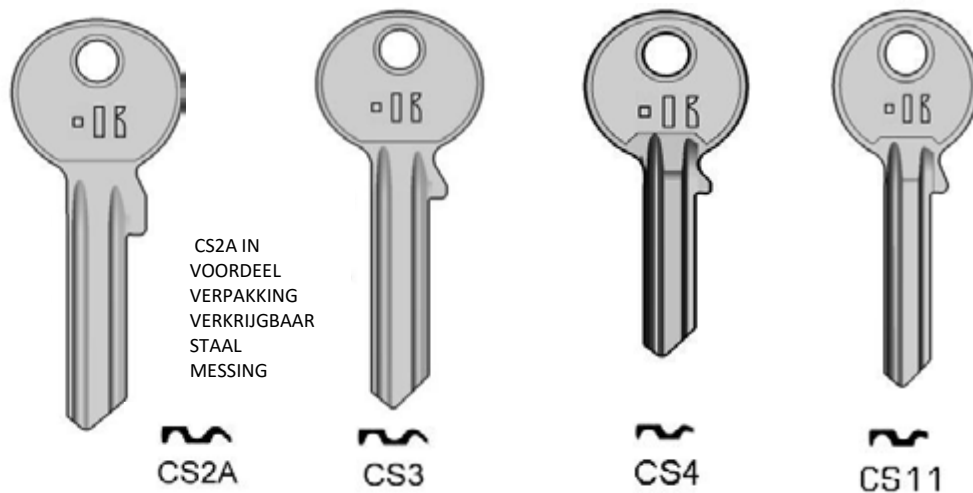

CS2A IN  
VOORDEEL  
VERPAKKING  
VERKRIJGBAAR  
STAAL  
MESSING

CS2A-    CE2X  
TOPSLEUTEL  
CS2A-ST    STAAL  
CS2A-MS    MESSING  
  
CS3    CE1  
CS4    CE4  
CS11    CE6

**CILINDERSLEUTELS**

**CES**



**CS13**



**CS15**



**CS16-T**



**CS17WPS**

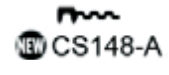

**CS17XPS**

- |         |         |
|---------|---------|
| CS13    | CE7     |
| CS15    | CE147   |
| CS16-T  | CE11    |
| CS17WPS | CE17WPS |
| CS17XPS | CE17XPS |
| CS148-A | CE148   |

**CES**



**CS18**

**LOPER  
 VOOR  
 DE KB  
 SERIE  
 VAN  
 NEMEF**

**CS20X**



**CS158S**

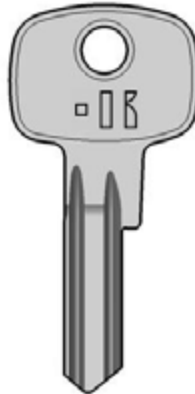

**CS41**

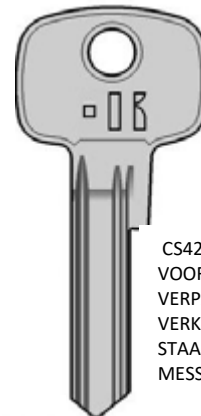

**CS42**

CS42 IN  
 VOORDEEL  
 VERPAKKING  
 VERKRIJGBAAR  
 STAAL  
 MESSING

**CS114**

- |            |           |
|------------|-----------|
| CS18       | CE18      |
| CS20X      | NME3R     |
| CS41       | CE41      |
| CS42       | CCE20/127 |
| TOPSLEUTEL |           |
| CS42-ST    | STAAL     |
| CS42-MS    | MESSING   |
| CS114      | CE114     |
| CS158S     | CE158     |

**CES**

**CVL**

**CITY**

**LOPER  
 VOOR DE  
 TZ SERIE  
 VAN  
 NEMEF**



**CS50S**



**CS100**



**CV3**



**CY2S**

- |                        |        |
|------------------------|--------|
| CS50S                  | CE14PS |
| CS100-LOPER VOOR DE    |        |
| CS42 CS114 CE154 CE155 |        |
| CV3                    | CVL3   |
| CY2S                   | CA2    |

**CILINDERSLEUTELS**

**DOM**



DO8      DM8  
DO8S      DM8R  
DO9S      DM19R  
DO11      DM10  
DO12      DM17  
DO12S      DM17R  
DO27      DM27



DO8

DO8S

DO9S

DO11

DO12

DO12S

**NEW** DO27

**DOM**

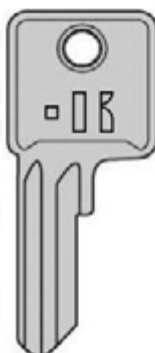

DO14 IN  
VOORDEEL  
VERPAKKING  
VERKRIJGBAAR  
STAAL  
MESSING

DO14      DM14/DM15  
TOPSLEUTEL  
DO14-ST      STAAL  
DO14-MS      MESSING  
DO5      DM3  
DO15      DM16  
DO16      DM15  
DO20      DM11



DO14

DO5

DO15

DO16

DO20

**DOM**



DO21      DM25  
DO39S      DM39R  
DO55      DO154  
DO55S      DM154R  
DO63      DM63

DO55 EN DO55S ZIJN  
LOPERS VOOR DE DOM  
RS SERIE



DO21

DO39S

DO55

DO55S

DO63



**CILINDERSLEUTELS**

**DOM**



**NEW DO110**

DO105S IS IN  
 VOORDEEL  
 VERPAKKING  
 VERKRIJGBAAR  
 STAAL  
 MESSING



**DO105S**



**DO150 - DO150S**  
 LOPERS VOOR DE DOM  
 SERIE 65 NUMMER 1 T/M  
 46

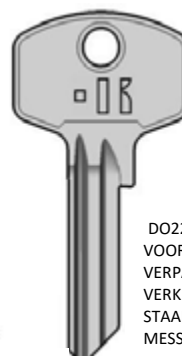

**DO220**

DO220 IN  
 VOORDEEL  
 VERPAKKING  
 VERKRIJGBAAR  
 STAAL  
 MESSING

DO110	DM110
DO105S	DM151R
DOM PLURA	
TOPSLEUTEL	
DO105S-ST	STAAL
DO105S-MS	MESSING
DO220	DM119
TOPSLEUTEL	
DO220-ST	STAAL
DO220-MS	MESSING
DO150	DM143
DO150S	DM143R

**ELZETT**

**EMKA**

**EURO-LOCKS**



**ELZ1**



**EMK1**



**EU10**



**EU10S**

**EU11S**

**NEW EU12**

ELZ1	EL1
EMK1	EMK1
EU10	EU10
EU10S	EU10R
EU11S	EU11R
EU12	EU12

**EURO-LOCKS**



**EU13S**



**NEW EU14S**



**NEW EU16S**



**EU18**

EU13S	EU13R
EU14S	EU14
EU16S	EU16R
EU18	EU18R

**CILINDERSLEUTELS**

**EURO-LOCKS**

**EVVA**



**NEW** EU56

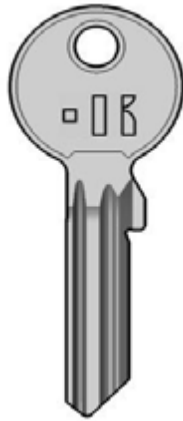

EV12-A

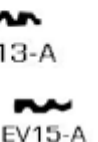
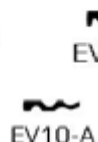

EV69-A



EV21S-A

EU56	LF57
EV5-A	EV3X
EV10-A	EV10X
EV11-A	EVVA-NLFG
EV12-A	EVVA-NLGC
EV13-A	EVVA-NLKG
EV14-A	O PROFIEL
EV15-A	S SERIE
EV69-A	EV69X
EV21S	EVVA-TSC

**EVVA**

**LOPER MODEL  
VOOR DE  
EVVA GPI**



EV30



EV3KS-203B



EV3KS-203C



EV3KS-204

EV30	GPI LOPER
EV3KS-203B	
EV3KS-203C	
EV3KS-204	

**EVERGOOD**



EVD2

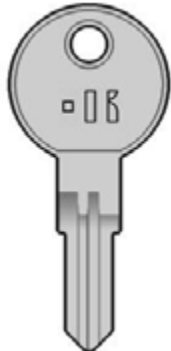

EVD3

EVD3S



EVD4





















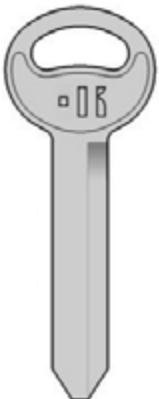







**NEW** EVD5

EVD2	ED4
EVD3	ED3
EVD3S	ED3R
EVD5	
EVD4	ED2



**CILINDERSLEUTELS**

FARMA		FAB			
				FARM2S	FAB2R
	 10X	 14X			
FARM2S	FB1-100X	FB1-140X	FB2-300	FB2-320	FB35S-A
					FARM2S
					FB1-100
					FB1-140
					FB2-300
					FB2-320
					FB19RX
					FB20RX
					FB35S-A
FORD		FF-FACCHINETT		FORT	
				FD11	FO14R
					
FD11	FF2	FF5	FOR1S	FOR2S	
					FF2
					FF5
					FF1
					FF2
					FOR1S
					FRT4R
					FRT5R
FORT		FTH			
				FOR3	FRT8
		 <b>NEW</b>			
FOR3	FTH11	FTH23S	FTH10		
					FTH11
					FH11
					FTH23S
					FH23R
					FH13

**CILINDERSLEUTELS**

**FCV      GIOBERT      GEGE      GHE**



**FV2**



**GB1S**



**GG2**



**GHE1      GHE2**

FV2	FV2
GB1S	GT1
GG2	GE1
GHE2	GHE1
GHE1	GHE2

**GIUSSANI      GLOBE      GTV**



**GIS2PD**



**GIS4**



**GIS4S**



**GIS5PD**

**GIS5PS**



**GO13**



**NEW GTV2-7-A**

GIS2PD	GS13
GIS4	GS4
GIS4S	GS4R
GIS5PD	SM1R
GIS5PS	SM1
GO13	GL13R
GTV2-7-A	EM7R

**HEKNA      HAFELE**



**HE1      NEW HE7**



**HE2**



















**HE4**



**HFL1      HFL1S**

HE2	HN1
HE4	HN4
HFL1	HF75R
HFL1S	HF75
HE1	HN3
HE7	HN7

**CILINDERSLEUTELS**

HAFELE		HUWIL		HORCE			
							
HFL3S	HFL3S	HL1	HL2S	HL2	HO1S		
					HFL3S HF74 HFL3 HF74R HL1 HW1 HL2S HW4R HL2 HW4 HO1S HO2R		
HOPPE		HR		HUDSON		HUNIT	
							
HOP1	HOP1S	HR1	HS1	HS1S	HUN5		
						HOP1 HPP1R HOP1S HPP1 HR1 HR1 HS1 HD1R HS1S HD1 HUN5 HUT5	
ICSA		IFAM		ILARGI		ISEO	
							
IC5	IF6	IL1S	ISE2	ISE31			
					IC5 ICS1 IF6 IF6 IL1S IL1 ISE2 IE2 ISE31 IE31		

**CILINDERSLEUTELS**

**ISEO**



ISE5D IN  
VOORDEEL  
VERPAKKING  
VERKRIJGBAAR  
STAAL  
MESSING

ISE4D IE7  
ISE5D IE6  
ISE5SM IE19  
ISE27S IE27  
ISE29 IE29  
ISE5PD IE3  
ISE27S = ISEO F3  
ISE29 = ISEO F6

TOPSLEUTEL  
ISE5D-ST STAAL  
ISE5D-MS MESSING

**JUNGHEINRIC**

**JPM**

**JOWIL**

**JU**

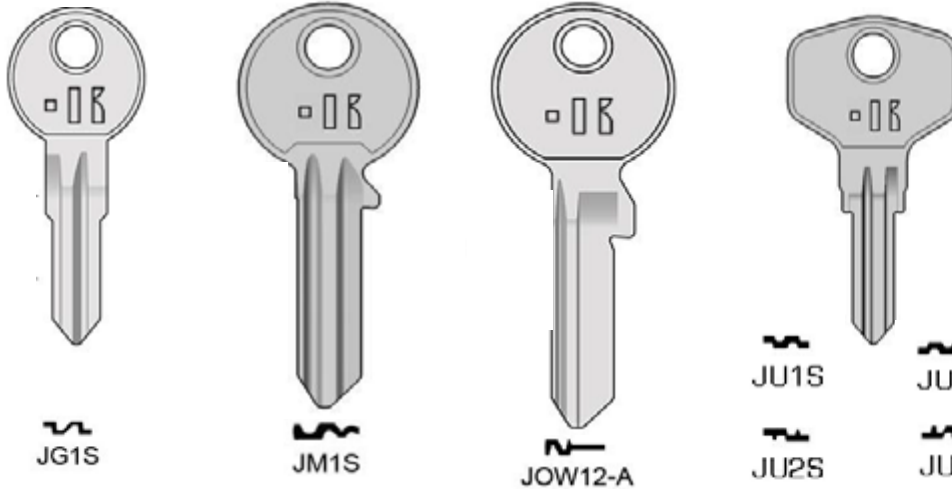

JG1S JR1R  
JM1S JM1R  
JOW12-A JOW12X  
JU1S JU11R  
JU1S JU11R  
JU2S JU13S  
JU3 JU12

**JUNIE**





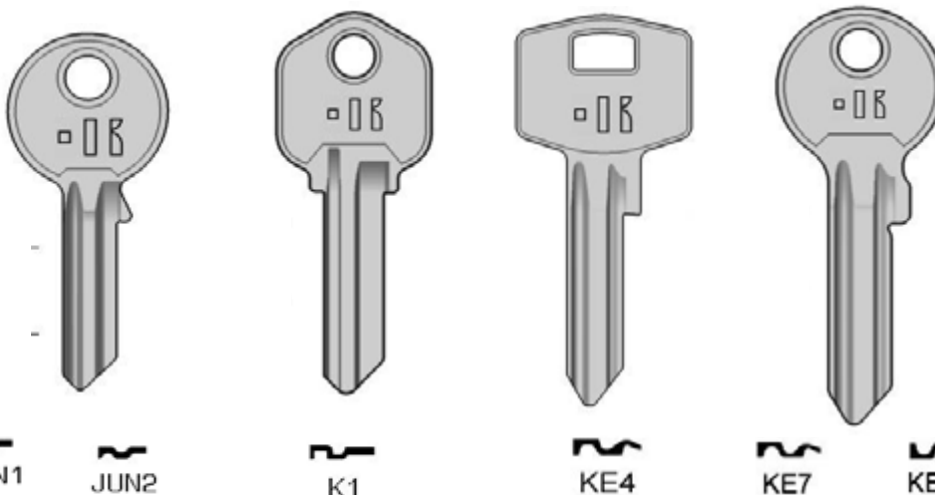



**KWIKSET**











**KALE**











JUN1 JU1  
JUN2 JU2  
K1 KS1  
K1 = NINO  
KE1 KLE1  
KE7 KLE7X  
KE7S KLE7RX

**CILINDERSLEUTELS**

KIFERM		KFV		LAS			
				KM13	KI13		
							
NEW KM13	KV1	LAS1	LAS3	LAS3S			
				LAS3 EN LAS3S IN VOORDEEL VERPAKKING VERKRIJGBAAR STAAL MESSING	TOPSLEUTELS		
					LAS3-ST	STAAL	
					LAS3-MS	MESSING	
					LAS3S-ST	STAAL	
					LAS3S-MS	MESSING	

LAS								
							LAS5	LS7
							LAS7	LS9
LAS5	LAS7	LAS7S	LAS9	LAS9S	LAS11	LAS11S	LAS7S	LS9R
							LAS9	LS13
							LAS9S	LAS13R
							LAS11	LS14
							LAS11S	LS14R

L&F								
							LF1S	EU1R
							TOPSLEUTEL	
LF1S	LF4S	LF3S	LF5	LF6			LF1S-ST	STAAL
							LF1S-MS	MESSING
							LF4S	EU3
							LF3S	EU5R
							TOPSLEUTEL	
							LF3S-ST	STAAL
							LF3S-MS	MESSING
							LF5	LF12
							LF6	LF26

## CILINDERSLEUTELS

### L&F



LF7	EU4
LF7S	EU4R
LF11	LF11
LF11S	LF11R
LF12S	LF8
LF14S	LF45R
LF61S	LF61R

LF7	LF7S	LF11	LF11S	LF12S	LF14S	<b>NEW</b> LF61S
-----	------	------	-------	-------	-------	------------------

### L&F



IN VOORDEEL  
VERPAKKING  
VERKRIJGAAR  
STAAL  
MESSING

LF18	LF36
LF19	LF19
LF19S	LF19R
LF23R	LF23R
TOPSLEUTEL	
LF23R-ST	STAAL
LF23R-MS	MESSING
LF24	LF22
LF24S	LF22R
LF20S	LF31R

LF18	LF19	LF19S	LF20S	LF23R	LF24	LF24S
------	------	-------	-------	-------	------	-------

### L&F



LF25	LF16
LF25S	LF16R
LF26	LF30R
LF27S	LF85
LF32	LF27
LF28S	LF59R

LF25	LF25S	LF26	LF27S	LF28S	LF32
------	-------	------	-------	-------	------

## CILINDERSLEUTELS

### L&F



**LF31**



**LF56**



**LF60**



**LF85 LF85S**

LF31	LF39
LF56	LF45
LF60	LF60
LF85	LF4
LF85S	LF4R

### L&F



**LF87**



**LF88**



**LI2**

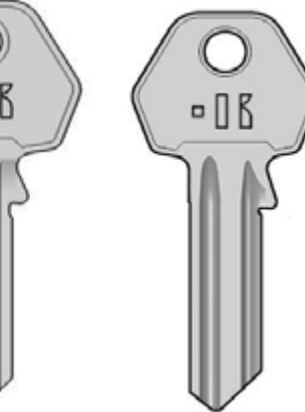

**LI2S**



**LI3**



**LI3S**

LF87	LP2
LF88	EU19
LI2	LP2
LI2S	LP2R
LI3	LP3
LI3S	LP3R

### LIPS



**LI6S**

LI6S IN  
 VOORDEEL  
 VERPAKKING  
 VERKRIJGBAAR  
 STAAL  
 MESSING



**LI7**



**LI7S**



**LI8**



**LI8S**

LI6S	LP57R
TOPSLEUTEL	
LI6S-ST	STAAL
LI6S-MS	MESSING















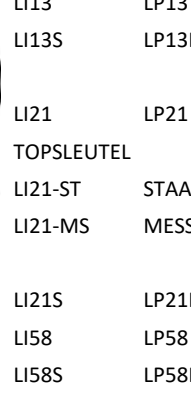











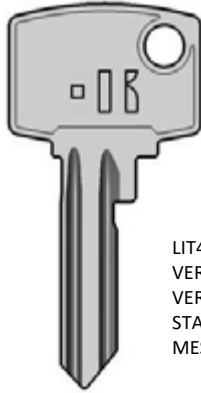



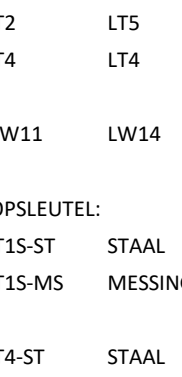

LI7	LP7/2
LI7S	LP7R/2R
LI8S	LP8R
LI8	LP8
LI12	LP12
LI12S	LP12R

**LI12**

**LI12S**

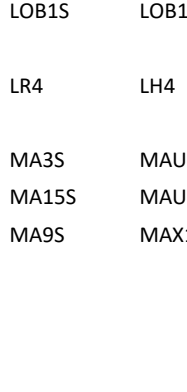
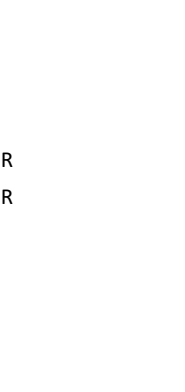

















## CILINDERSLEUTELS









LIPS				LINCE							
								L113	LP13		
								L113S	LP13R		
L121 IN VOORDEEL VERPAKKING VERKRIJGBAAR STAAL MESSING								L121	LP21		
								TOPSLEUTEL			
								L121-ST	STAAL		
								L121-MS	MESSING		
								L121S	LP21R		
								L158	LP58		
								L158S	LP58R		
								LIN2S	LC2R		
								LIN15	LC15		
LITTO				LOCKWOOD							
									LIT1S	LT2	
LIT1S IN VOORDEEL VERPAKKING VERKRIJGBAAR STAAL MESSING		LIT4 IN VOORDEEL VERPAKKING VERKRIJGBAAR STAAL MESSING								LIT2	LT5
										LIT4	LT4
										LKW11	LW14
										TOPSLEUTEL:	
										LIT1S-ST	STAAL
										LIT1S-MS	MESSING
										LIT4-ST	STAAL
										LIT4-MS	MESSING
										LIT6S	
LOB	LAPERCHE	MAUER									
										LOB1S	LOB1
										LR4	LH4
										MA3S	MAU1R
										MA15S	MAU5R
										MA9S	MAX1
										MAUER MA9S	



## CILINDERSLEUTELS

MCM		MICHEAL-SEAT		MERONI	
				MC1S	MC2R
				MC1	MC2
				MC12	MC12
				MCH7S	OMR1R
				ME5D	MER8

MERONI					
				ME17T	MER22T
				ME18T	MER25T
				ME34	MER34R
				ME35	MER35R

MERONI		MEFA			
				ME40PD	MER2
				ME41PD	MER1
				ME42PD	MER4
				ME42PS	MER4R
				MEF1S	MF1R

## CILINDERSLEUTELS

### MLM



MLM1 **NEW** MLM1S

### MG-MONTI

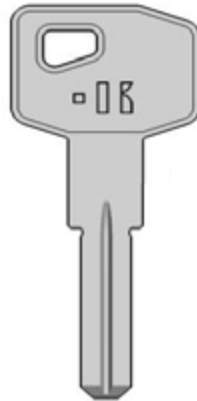

**NEW** MN9



MRT1S

MLM1	MLM1
MLM1S	MLM1R
MN9	MN9 -
MRT1S	MRT1R

### MASTER



MST2S



**NEW** MST19



MST20

### NEIMAN



**NEW** NE5

MST25	MS3
MST19	MS19
MST20	
NE5	NE5

### NEMEF



NF20S

IN VOORDEEL  
VERPAKKING  
VERKRIJGBAAR  
STAAL



NF21S

NF22S

NU4

### NS



OJ6

### OJMAR





































**NEW** OJ17S

NF20S	NME1R
NF21S	NME2R
NF22S	NME4R

NF20S	NF2
NF21S	NF1
NF22S	NF3

TOPSLEUTEL	
NF20S-ST	STAAL
NU4	NS4
OJ6	OJ6R
OJ17S	OJ17R

## CILINDERSLEUTELS

OMR		PFAFFENHAIN			POTENT	
		 PFA1S	 PFA8		OM1	OM1
		 PFA2S	 PFA8S		POT1S	PT1
		 PFA3S			PFA1S	PHF2R
		 PFA4S	 PFA9		PFA2S	PHF19
		 PFA6S	 PFA9S		PFA3S	PHF1R
		 PFA7S			PFA4S	PHF17
 NEW OMR1				 POT1S	PFA6S	PHF16R
					PFA7S	PHF18R
					PFA8	PHF26
					PFA8S	PHF26R
					PFA9	PHF27
					PFA9S	PHF27R
PREFER		ROLL-DOOR		RONIS		
					PR1D	PF1
					PR5SM	PF092
					RD2	RD2
					RI2	RO20
					RI2S	RO20R
 PR1D	 PR5SM	 RD2	 RI2	 RI2S		
RONIS						
					RI3	RO8
					RI10	RO4
					RI10S	RO4R
					RI11	RO21
					RI11S	RO21R
					RI17S	RO69
 RI3	 RI10	 RI10S	 RI11	 RI11S	 RI17S	

## CILINDERSLEUTELS

### RONIS

### RUKO



RI18 RO41  
RI19 R067R  
RI20 RO68  
RI20S RO68R  
RI21 RO77

RI18

RI19

RI20

RI20S

RI21

RI21

RK1 RU1

### RENZ

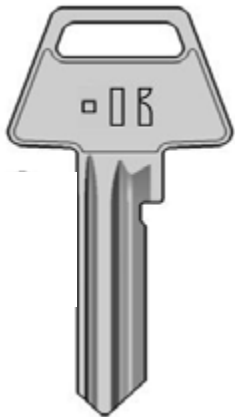

RK14 RU14  
RZ1 REN1  
RZ1S REN1R  
RZ2 REN2  
RZ2S REN2R  
RZ3S REN3R  
RZ4S REN4R

RK14

RZ1

RZ1S

RZ2

RZ2S

RZ3S

RZ4S

### RENZ

### SOFI-SONAFI

### SATURN



RZ10 REN6R  
S1S S11R  
S4S S14R  
SAT1-A STU1

































RZ10





























S1S













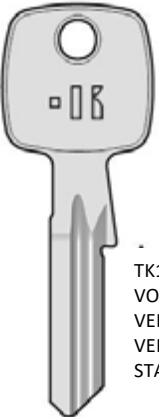











S4S

SAT1-A

## CILINDERSLEUTELS

STAR		STARLET		TRI-CIRCLE	
				STA10	STA10
				STA10S	STA10R
				ST2S	STL2R
				ST51	STS1
				TC2D	TL7
				TC2S	TL7R
				TC3D	TL6
				TC3S	TL6R

TRI CIRCLE						
				TC6D	TL1	
				TC5S	TL1R	
				TC9D	TL9R	
				TC60D	TL2	
				TC60S	TL2R	
				TC61D	TL3	
				TC61S	TL3R	

TESA		TOK-WINKHAUS		TOP-NOVA	
				TES3	TE3
				TES5	TE2
				TES6	TE6
				TK1	TO1
				TK1-A	TO1-X
				TK10SL	TO120RX
				TK10SL-ST	TOPSLEUTEL
				TK10SL-MS	STAAL
				TOP1S	MESSING
				TOP1S	TOP1R/ABS
				TOPSLEUTEL	TOPSLEUTEL
				TOP1S-ST	STAAL
				TOP1S-MS	MESSING

## CILINDERSLEUTELS

TRIOVING	UMEC	UNIVERSEEL	
----------	------	------------	--



TV4



NEW UM1S



NEW UN3PD



UN4PD

TV4	TR1
UM1S	UC1R
UN3PD	UL056
UN4PD	UL060

## UNIVERSEEL



UN4D UN4S



UN5D UN5S

UN5D en UN5S  
IN VOORDEEL  
VERPAKKING  
VERKRIJGBAAR  
STAAL  
MESSING



UN5PD UN5PS



UN6D UN6S

UN4D	UL052
UN4S	UL053
UN5D	UL050
UN5S	UL051
TOPSLEUTEL	
UN5D-ST	STAAL
UN5D-MS	MESSING
UN5S-ST	STAAL
UN5S-MS	MESSING

UN6D	UL054
UN6S	UL055

## UNIVERSEEL

## UNI

## UNION



UN7D



UNI1



UNI2



UNKB2

UN7D	UL046
UNI1	UNI8
UNI2	UNI11A
UNKB2	UNI3

## CILINDERSLEUTELS

### VACHETTE



VC1

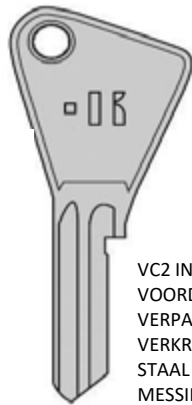

VC2

VC2 IN  
 VOORDEEL  
 VERPAKKING  
 VERKRIJGBAAR  
 STAAL  
 MESSING



VC4

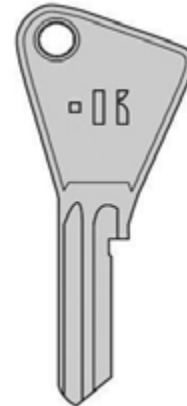

VC8

VC1 VAC1  
 VC2 VAC2  
 VC4 VAC14  
 VC8 VAC48

#### TOPSLEUTEL

VC2-ST STAAL  
 VC2-MS MESSING

### VACHETTE



VC11



VC14S



VC25



VC26

VC11 VAC46  
 VC14S VAC25  
 VC25 VAC29  
 VC26 VAC151

### VACHETTE

### VIRO

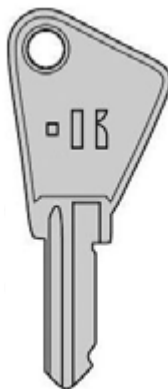

VC39



VR4PD

VR4PS

VR5D IN  
 VOORDEEL  
 VERPAKKING  
 VERKRIJGBAAR  
 STAAL  
 MESSING



VR5D

VR5S

VR5PD

VR5PS



VR7S

VC39 VAC61  
 VR4PD VI084  
 VR4PS VI085  
 VR5D VI080  
 VR5S VI081  
 VR5PD VI086  
 VR5PS VI085  
 VR7S VI087

#### TOPSLEUTEL:

VR5D-ST STAAL  
 VR5D-MS MESSING



## CILINDERSLEUTELS

VIRO	VIS	WANGGUAN
------	-----	----------



VR20



NEW VS9



WAN1

VR20	VI4
VS9	VS090V
WAN1	WGU1

WASO	WILKA
------	-------



WAS2 WAS3



WI1A

IN VOORDEEL  
VERPAKKING  
VERKRIJGBAAR  
STAAL

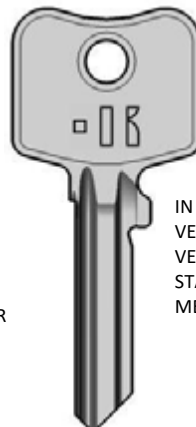

WI2

IN VOORDEEL  
VERPAKKING  
VERKRIJGBAAR  
STAAL  
MESSING



WI59S-A

WAS2	WAS2
WAS3	WAS3
WI1A	WK1X
TOPSLEUTEL	
WI1A-ST	STAAL
WI2	WK55
TOPSLEUTEL	
WI2-ST	STAAL
WI2-MS	MESSING
WI59S-A	WK59R

WILKA	WELKA	WEISER
-------	-------	--------



WI100



WI50



WK4D



WK5S



WS2













WR2-T













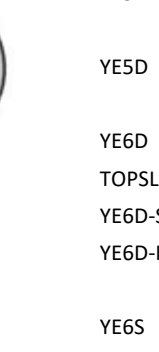

WR7

WI100	WK62R
WI50	WI100 MET
ORIGINELE KOPVORM	
WK5S	WE1R
WK4D	WE13
WR2-T	WE12
WR7	WE11
WS2	WE15















## CILINDERSLEUTELS

WALLY		XIEHE		YALE				
							WYD5D	WA1
								
WY5D	<b>NEW</b> XI1	YE3-T	YE3S-T	YE4PD	YE4PS	YE4D	YE3-T	YA2
							YE3S-T	YA2R
							YE4PD	YA13
							YE4D	YA6

YALE									
								YE5PD	YA7
								YE5D	YA226
YE2	YE2S	YE5PD	YE5D	YE6D	YE6S	YE7	YE7S	YE6D	YA31
								TOPSLEUTEL	
								YE6D-ST	STAAL
								YE6D-MS	MESSING
								YE6S	YA31R
								YE7	YA4
								YE7S	YA4R
								YE2	YA14
								YE2R	YA14R

YE6D IN  
 VOORDEEL  
 VERPAKKING  
 VERKRIJGBAAR  
 STAAL  
 MESSING

YALE							
						YE8	YA3
						YE11	YA35
YE8	YE11	YE50	YE12	YE14	YE14S	YE12	YA89
						YE14	YA18
						YE14S	YA18R
						YE50	YA5

## CILINDERSLEUTELS

### YALE



 YE15

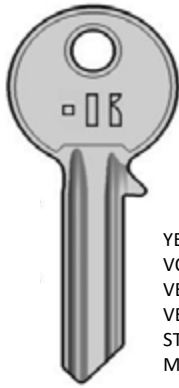

 YE51S

 YE51

YE51 IN  
VOORDEEL  
VERPAKKING  
VERKRIJGBAAR  
STAAL  
MESSING



 YE70S

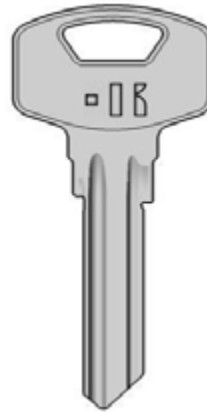



 YE91

YE15      YA8  
YE51      YA1/226  
TOPSLEUTEL  
YE51-ST    STAAL  
YE51-MS    MESSING  
  
YE70S  
YE91      YA91

### YETI

### ZEIS-IKON



 YET1     YET1



 YET15



 ZI2

 ZI2S-A



 ZI3

YET1S      YT1  
YET15      YT15  
YET1      YT1R  
ZI2      ZE1  
ZI2-A      ZE1RX  
ZI3      ZE2

ZI14-A      ZE12X







 ZI14-A







## FIETS- EN SCOOTERSLEUTELS

**FIETS -SCOOTER**





**ABLOY ABUS**

				AB1P	AY1P
				ABU12P	AB38P
				ABU7P	AB82RAP
				ABU57P	AB57AP
				ABU57SP	AB57RAP

**ABUS**

				ABU65SP	AB65RAP
				ABU66SP	ABB66RP
				ABU67SP	AB58RAP
				ABU68SP	AB59RP

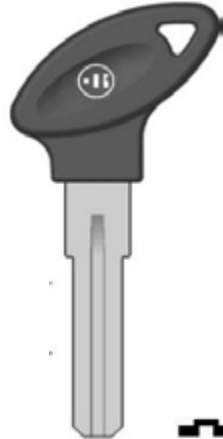
**ABUS AXA**

				AXA1P	AX7RAP
				AXA1BP	AX7RAP
				AXA1BP - LANGERE	
				HALS EN SCHUINE	
				KOPVORM	
				AXA2P	AX4RP
				ABU82P	T83 EN T82

**FIETS -SCOOTER**

**AXA**

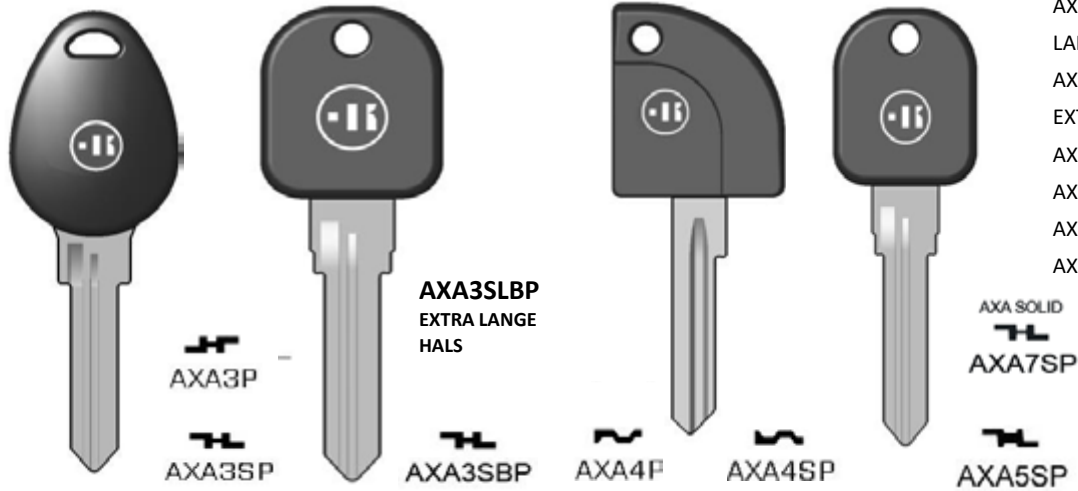

AXA3SBP    AX1RP MET  
 LANGERE HALS  
 AXA3SLBP    AX13RDP  
 EXTRA LANGE HALS  
 AXA4P    ASS96P  
 AXA4SP    ASS96RP  
 AXA5SP    AX5RP  
 AXA7SP

**AXA**

**EURO-LOCKS**

**STAHLEX**

**GIANT**



EPK1P    STH1RP  
 EPK1SP    STH1P  
 EU15P    EU21P  
 GNT1P    GNT1P  
 AXA6P    AX9CP

**HONDA**





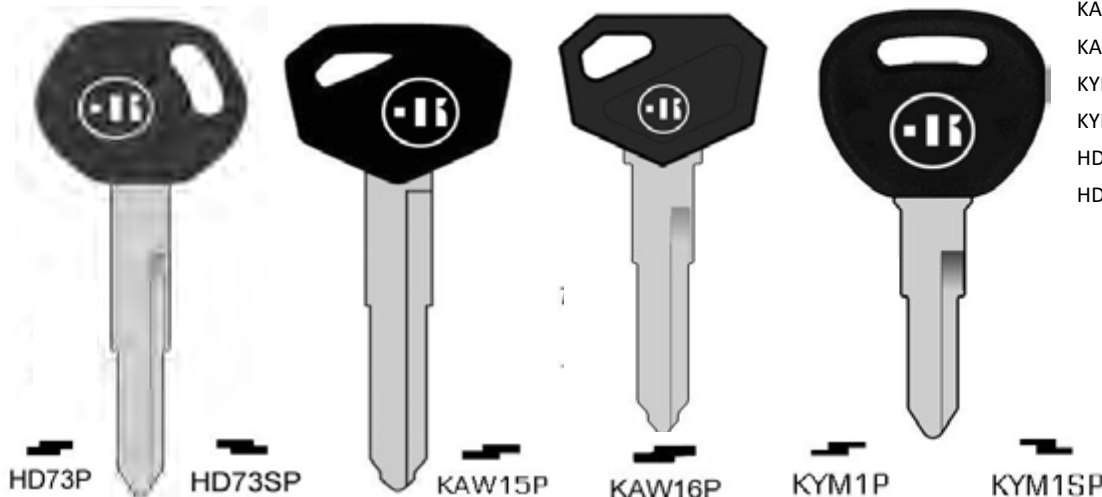





**KAWASAKI**

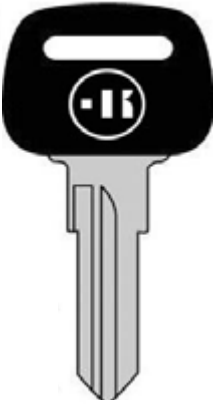

**KYMCO**







KAW15P    KW15BP  
 KAW16P    KW14P  
 KYM1P    KYM1P  
 KYM1SP    KYM1RP  
 HD73P    KYM3AP  
 HD73SP    KYM3RAP

**FIETS -SCOOTER**

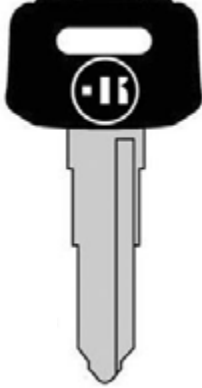
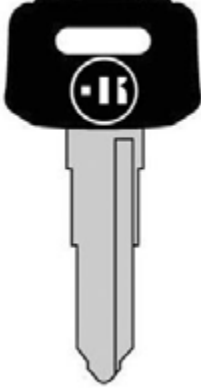
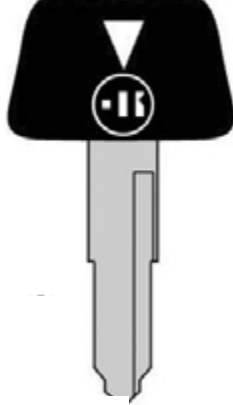
KYMCO		PGO	PEUGEOT	STARRY		
					KYM2P	KYM2P
					KYM2SP	KYM2RP
					KYM3P	KYM3AP
					KYM3SP	KYM3RAP
					PGO1P	PGO2P
					PG32P	NE74P
					STR1SP	STY1RP

SUZUKI		TRELOCK			
				SU14SP	SZ10RP
				TRK1P	TRK1P
				TRK2P	TRK6P
				TRK3P	TRK7P

TRELOCK	YAMAHA				
				TRK4P	TRK8DP
				TRK5P	TRK11DP
				YM8P	YH28P
				YM8SP	YH28RP
				YM9P	YH29P
				YM9SP	YH29RP
				YM10P	YH30P
				YM10SP	YH30RP
				YM10AP	

**FIETS -SCOOTER**

**YAMAHA**



- YAM-M05A
- YAM-M05B
- YAM-M08
- YAM-M10A
- YAM-M10B

YAM-M05A

YAM-M05B

YAM-M08

YAM-M10A

YAM-M10B

**YMS**

**ZADI**

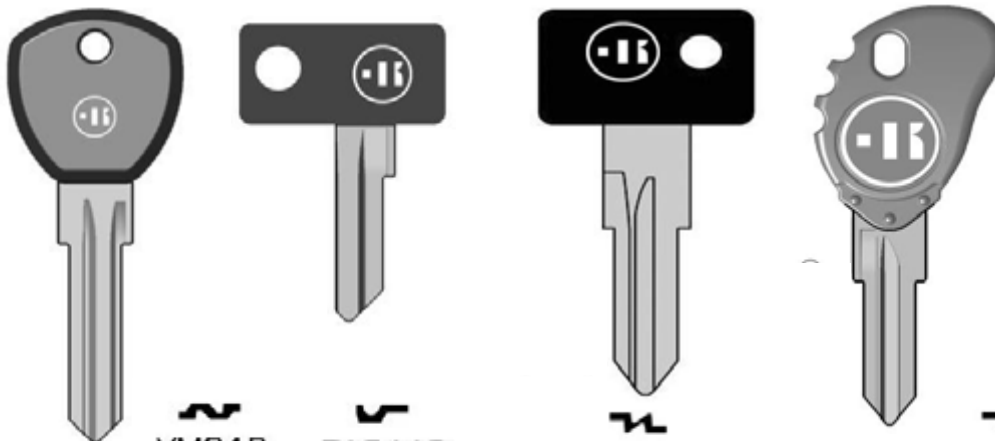

- YMS1P
- ZAD11P
- ZAD16P
- ZAD18P
- YW1P
- ZD9
- ZD14RP
- ZD23RCP

YMS 1P

ZAD11P

ZAD16P

ZAD18P

**ZADI**

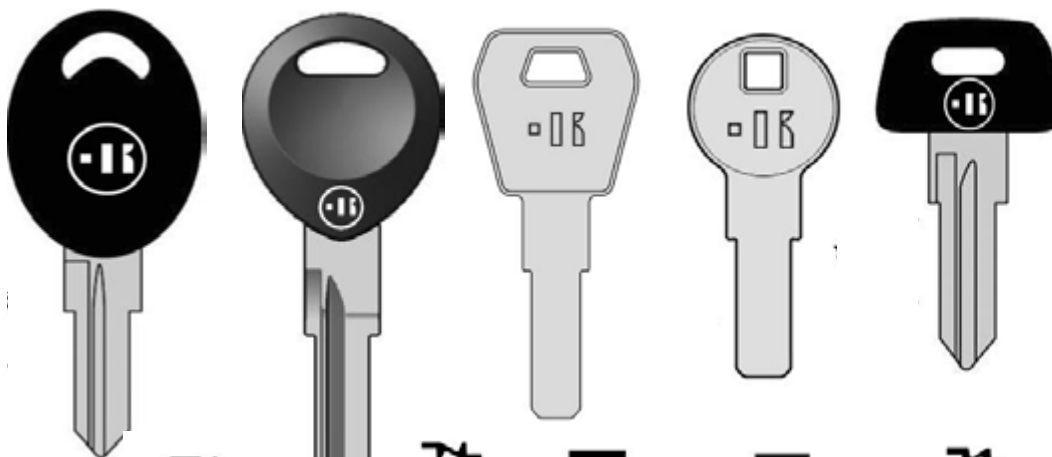

- ZAD19SAP
- ZAD20P
- ZAD25
- ZAD26
- ZAD27
- ZD22RBP
- ZD24RDP
- ZD25
- ZD26
- ZD17RDP

ZAD19SAP

ZAD20P

ZAD25

NEW ZAD26

ZAD27P











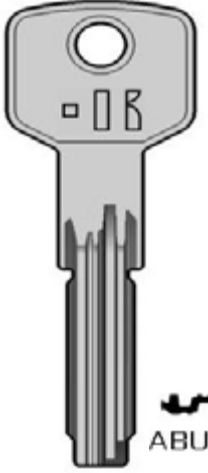

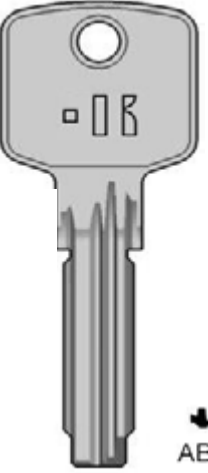
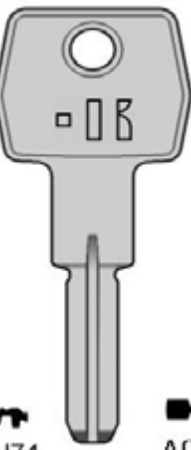

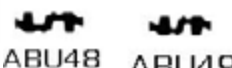

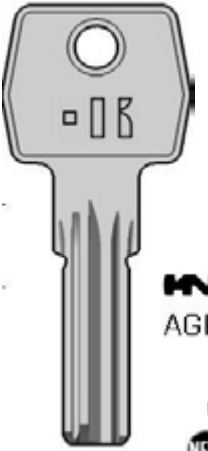
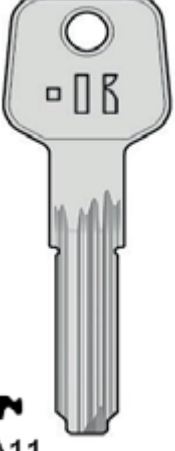

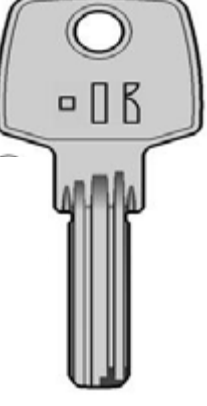
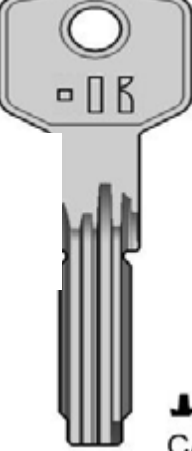





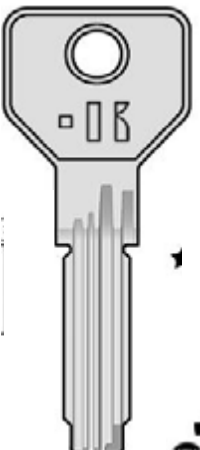
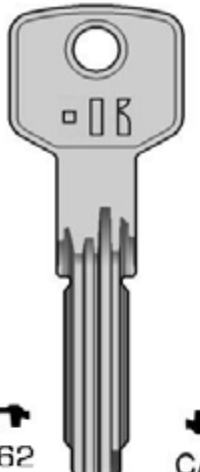
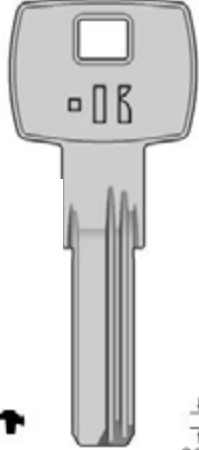
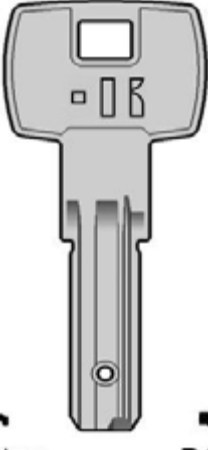
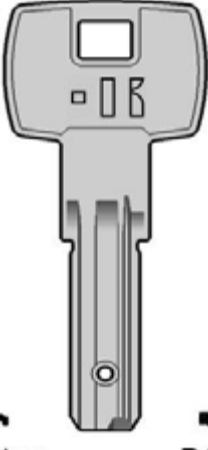









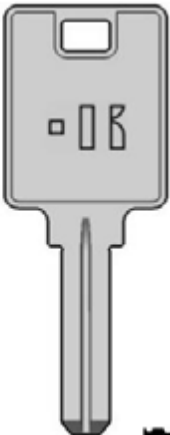









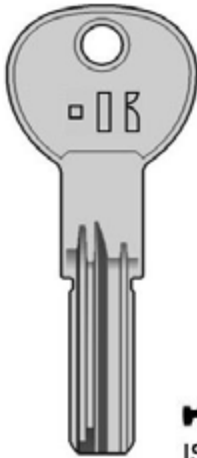
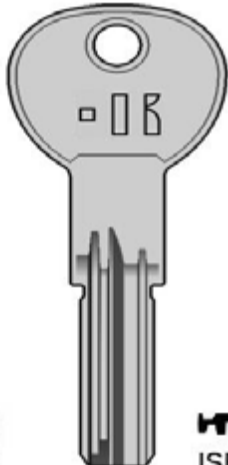

## BANEN- EN BORINGSLEUTELS

**BANEN- EN BORINGSLEUTELS**

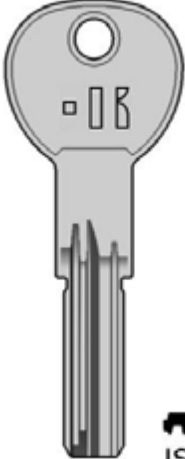
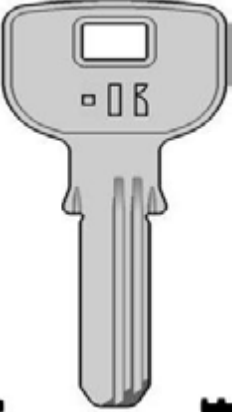
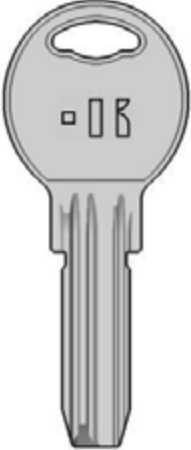
AXA		ABUS		AGB			
					AXA12    AX12 ABU48    AB48 ABU49    AB62 ABU74    AB74 AGB1      AGB5		
							
NEW AXA12		ABU48	ABU49	ABU74	AGB1		
AGB		BASI		CES		CISA	
					AGB6    AGB6 BA11 CA48    CS48 CA57    CS145 CE131    CE131		
							
AGB6	NEW BA11	CS131	CA48	CA57			
CISA		DEKABA		DOM			
					CA62    CS62 CA62P    CS62P CA60    CS146 DK6      DK6 DO100X    DM139		
							
NEW CA62	ASIX CA62 CA62P	CA62P	2,32 mm Thickness NEW DK6	DO100X			

**BANEN- EN BORINGSLEUTELS**

DOM	DS	EURO-LOCKS	FTH		
				DS2	DS4
				EU8	EU17
				FTH12	FH12
				DO102X	
					
DO102X	DS2	EU8	NEW FTH12		
HUWIL	ICSA	ISEO			
				HL3S	HW15R
				IC1	LC14R
				ISE15	IE15
				ISE15P	IE15P
				ISE17	IE26
					
HL3S	IC1	R6 ISE15	ISE17		
ISEO	KALE	KALE S2			
				ISE20	IE15
				ISE30	IE30
				KE1	KLE1
				KE10S	KLE10R
					
R6 ISE20	ISE30	KE1	KE10S		

## BANEN- EN BORINGSLEUTELS

GLOBE		KESO	
-------	--	------	--



**KL109**



**KS1**



**KS2**



**NEW KS2X**

KL109	GO6
KS1	KE1
KS2	KE2
KS2X	KE19

KESO	LIPS	MAUER
------	------	-------

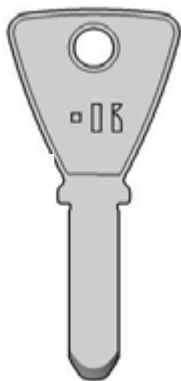

**KS3**

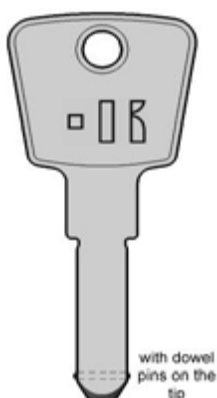

**NEW KS13X**



**LI11**



**MA1S**

KS3	KE3
KS13X	KE19
LI11	LP11
MA1S	DK1

MAGNUM	MCM	MULTI-LOCK	
--------	-----	------------	--

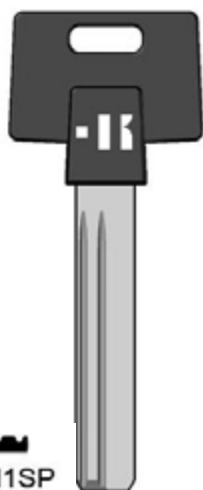

**MGN1SP**

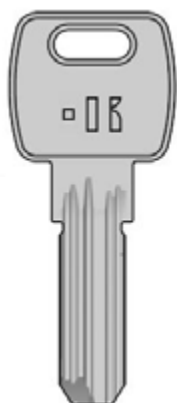

**MC15S**

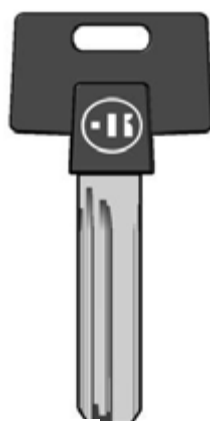

**ML6P**

**ML7P**



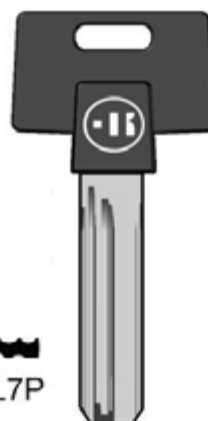







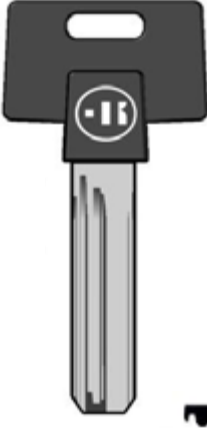
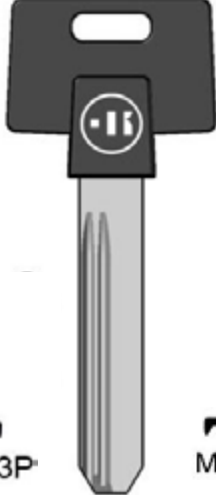

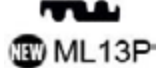

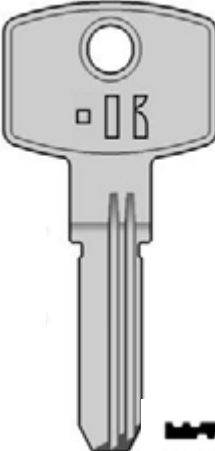
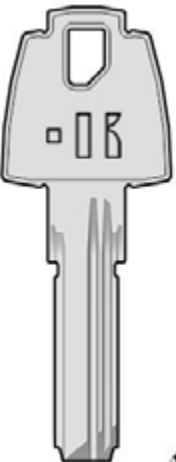
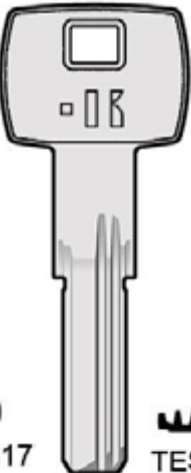

**ML4P**



**ML8P**

MGN1SP	MGN1RP
ML4P	MTK4RP
ML6P	MTK9RP
ML7P	ML7P
ML8P	ML8P
MC15S	MC15R

**BANEN- EN BORINGSLEUTELS**

MULTI-LOCK		STS		TESA	
				ML14P	ML14P
				ML13P	MTK13RAP
				STS6	STS6
				TES4	TE5
TESA				WILKA	
				TES17	TE19
				TES19	TE19
				LANGERE HALS	
				TES8	EC5
				WI36-A	WK70X
ZADI					
				ZAD25	ZD25
				ZAD26	ZD26











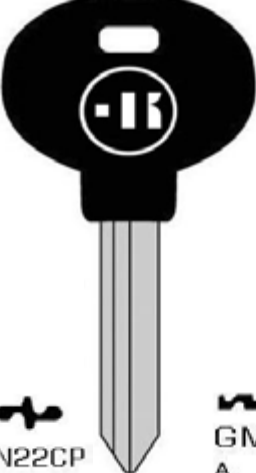
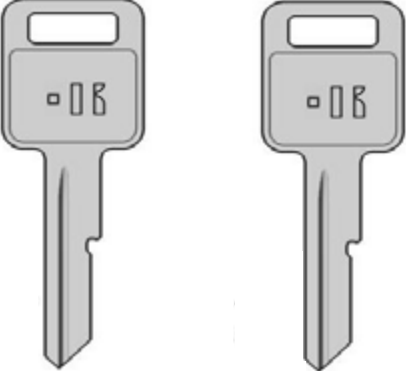







## AUTO - CARAVAN - TANKDOP- HEFTRUCK

**AUTO - CARAVAN - TANKDOP - HEFTRUCK**

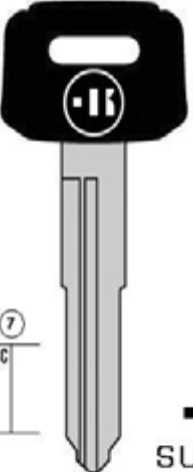
**CITROEN                      GENERAL MOTORS                      PEUGEOT**

			CN22AP	SX9GP	
			GM1	GM1	
			GM2	GM5	
			GM3	GM2	
			GM4	GM7	
 CN22CP	 GM1 A	 GM2 E	 GM3 C	 GM4 J	 PG32P

**MAZDA                      SUZUKI                      TOYOTA                      VOLKSWAGEN**













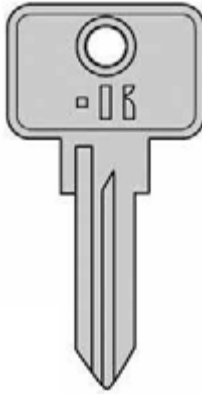







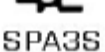

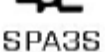

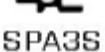
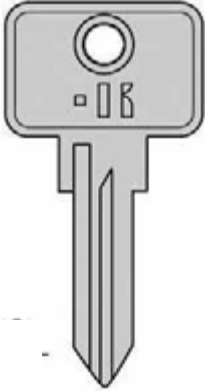
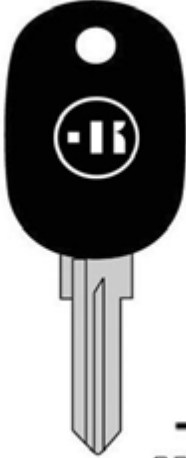
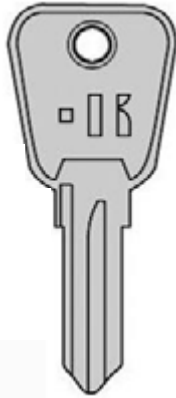







				MZ20P	MAZ20REP
				SU14SP	SZ10RP
				TR42	TOY38RP
				V13P	HU49P
 MZ20P	 SU14SP	 TR42	 V13P		

**VOLKSWAGEN**

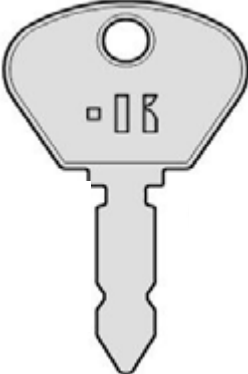
	V66-	HU66P
 NEW V66P		



**AUTO - CARAVAN - TANKDOP - HEFTRUCK**





EURO-LOCKS		GHE		SISPA	
				EU10	EU10
				EI10S	EU10R
				EU15P	EU21P
				GHE1	GHE1
				GHE2	GHE2
				SPA3S	SPA3R
				SPA4S	SPA4R
				SPA5S	SPA5R
SISPA		UNION			
				SPA4SP	SPA4RAP
				UNI1	UNI8
				UNI2	UNI11A
					
					
					
BOSCH		MRT		OMR	
				BH1	BH4
				MRT1S	MRT1R
				OM1	OM1
					
					



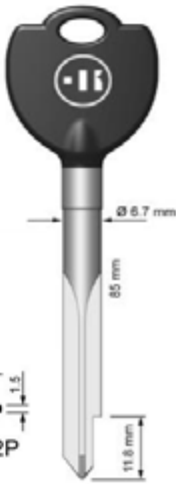

# STERSLEUTELS

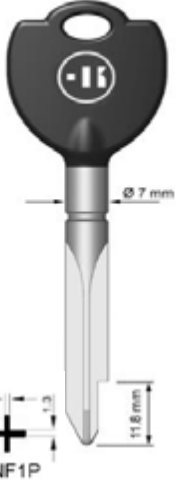
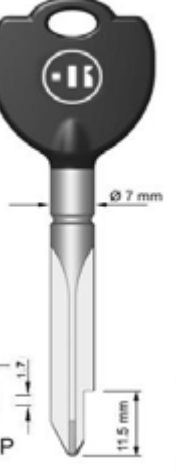
## STERSLEUTELS

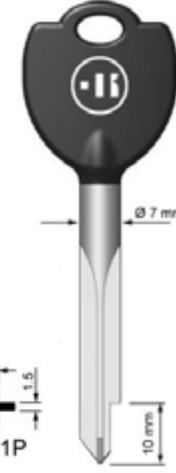
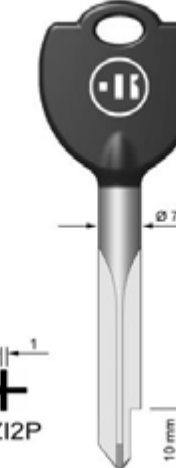
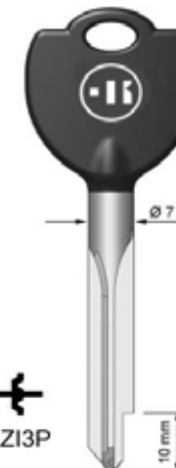
BURG		FIAM		NEMEF (DX)	
				XBU1P	XBW1
				XBU2P	XBW2
				XFIA2P	XF2
				XNF1P	XN1
NEMEF		YALE		ZASO	
				XNF2P	XN2
				XYE2P	XY4P
				XZA1P -	
				XZI1P	XZ1A
ZEIS IKON					
				XZI2P	XZ2A
				XZI3P	XZ3A



## ORGINELE SLEUTELS

## ORIGINELE SLEUTELS

### ABUS



8N



ABUS PLUS



ABUS X-PLUS



F82

### ABUS



NW72



T82/E6



T82



U72

### ABUS



V63



V65



Z73



Z74

**ORIGINELE SLEUTELS**

**PFAFFENHAIN**

**XOLID**



**D ORIGINEEL IN  
 NIEUW ZILVER**



**EA ORIGINEEL IN  
 NIEUW ZILVER**



**SRA ORIGINEEL  
 MESSING VERNIKKELD**



**FD ORIGINEEL MESSING  
 VERNIKKELD**



**XOLID**

**GAD**



**GADKB17LS**



**GADKB17RS**



**GADKB19LS**



**GADKB19RS**

**GAD**



**KA2**



**KB1**



**KB24**



**KB25**

**ORIGINELE SLEUTELS**

**GAD**



**KB30**

**KB32**

**KB50**

**KB58**

**GAD**



**KB65**

**KD26**

**KE1S**

**KE23**

**GAD**





# TRANSPONDERS

---

**TRANSPONDERS**

---

**T5**



**CKG**

**TEXAS 80 BIT TRANSPONDER VOOR EEN AANTAL KIA'S - HYUNDAI EN TOYOTA**



**CKH**

**TEXAS TRANSPONDER VOOR TOYOTA H**



**CK50**

**PHILIPS TRANSPONDER PH1B, PH1C EN PH1E**



**XT27**

**VVDI SUPER CHIP**



## TRANSPONDERS

### TKXX

LEGE BEHUIZING VOOR DE T5, CKG EN DE GLAZEN TRANPONDERS GKM EN GK100



### TK100

TK100 IS GESCHIKT VOOR O.A. ID46 - 4C EN 4D TRANSPONDERS. TEVENS OOK TE GEBUIKEN ALS VERVANGING VOOR DE T5 EN CKG TRANSPONDER.



### CK100

CK100 IS GESCHIKT VOOR DE ID46 - 4C EN DE 4D TRANSPONDER



---

## TRANSPONDERS

---

### GK100

GLAZEN TRANSPONDER VOOR DE ID46 - 4C EN 4D TRANSPONDER



### TKM

TRANSPONDER GESCHIKT VOOR DE ID48 VAG GROEP



### GKM

GLAZEN TRANSPONDER GESCHIKT VOOR DE ID48 VAG GROEP



### MAVIK

UNIVERSELE AFSTANDBEDIENING VOORZIEN MET EEN UNIVERSELE TRANSPONDER. DEZE IS TE PROGRAMMEREN VIA DE STAK



---

## TRANSPONDERS

---

### TRS-22

#### TRANSPONDER PCF7935AA



### TRS-24

#### TRANSPONDER ID40



### MQB TRANSPONDER



### VVDI ID48











































# TRANSPONDER SLEUTELS HOEFIJZERMODEL

## HOEFIJZER MODELLEN

ALFA ROMEO - FIAT		GM	BMW	
				AR16U GT16MH AR20U SIP16RMH
				B106U B111-PT
				BM2U HU92RMH
BMW	CITROEN	CHEVROLET		
				BM9U BW9MH
				CN22U SX9MH
				DAE47U DW05MH DAE47SU DW05RMH DAE48U DW04MH DAE48SU DW04RMH
CHEVROLET	DAIHATSU	FORD		
				DAE49U DW06MH
				DAI1SU DH4RMH
				FD3U FO21MH FD20U FO26MH



## HOEIJZER MODELLEN

FORD		FIAT		
				FD21U FO38RMH FD40U HU101MH
				FT22U SIP22MH FT59U GT15RMH
FD21U	FD40U	FT22U	FT50U	
FIAT		HONDA		
				FT1505U GT15RMH
				HD1U HON66MH
NEW FT1505U	HD1U	HD70U	HD71U	HD70U HON70MH HD71U HON63MH
HONDA		SCANIA	VAG GROEP	
				HD72U HON58RMH HD90U HON58RMH
				HU71U HU71MH HU162U HU162MH
HD72U	HD90U	HU71U	NEW HU162U	

## HOEFIJZER MODELLEN

### VAG GROEP

### HYUNDAI

HU163SU VAG

HY6U HYN6MH  
HY7SU HYN7RMH  
HY10U HYN10MH



HU163SU



HY6U



HY7SU



HY10U

### HYUNDAI

HY12U HYN12MH  
HY14U HYN14MH  
HY14SU HYN14RMH  
HY20U HU87RMH  
HY21U HYN17MH  
HY21SU HYN17RMH



HY12U



HY14U

HY14SU



HY20U



HY21U

HY21SU

### ISUZU

### KAWASAKI

### KIA

ISU5U ISU5MH

KAW12SI KW16MH

KI3SU KIA3RMH



ISU5U



KAW12SU



KI3SU

## HOEIJZER MODELLEN

TOYOTA		MERCEDES		MITSUBISHI	
				KI22U	TOY49MH
				MB57U	HU64MH
				MT1U	MIT8MH
				MT8SU	MIT11RMH
MITSUBISHI		MAZDA		NISSAN	
				MT11U	Y162P-PTMH
				MT15U	HU56RMH
				MZ24U	MAZ24RMH
				NS27U	NSN11MH
NISSAN		OPEL		PEUGEOT	
				NS34U	NSN14MH
				OPL1U	DWO5MH
				PG31U	NE78MH

## HOEFIJZER MODELLEN

PEUGEOT	DACIA- RENAULT	ROVER
---------	----------------	-------



PG33U



PG83U



RN30U



RV3U

PG33U VA2MH

PG83U HU83MH

RN30U NE73MH

RV3U NE71RMH

ROVER	SUZUKI
-------	--------



RV4U



SU13SU



SU14SU



SU15U

RV4U NE38MH

SU13SU SZ13RMH

SU14SU SZ17RMH

SU15U SZ12RMH

SUZUKI
--------

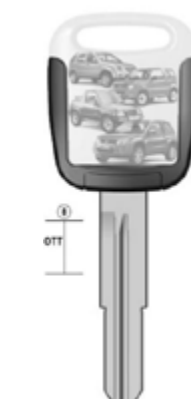

SU17U



SU17SU



SU18U

SU17U SU11RMH

SU17SU SU11MH

SU18U HU87RMH

SU19U HU133RMH

## HOEFIJZER MODELLEN

### SUZUKI

### SUBARU



SU20U



SU21U



SUB1U

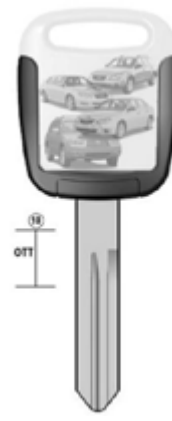

SUB2U

SU20U HU134MH  
 SU21U SZ17RMH

SUB1U DAT17MH  
 SUB2U NSN19MH

### SSANG SONG

### TOYOTA



NEW SY3SU



TR41U

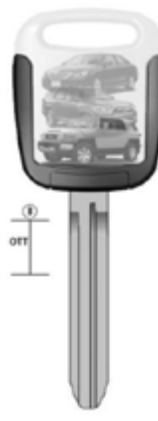

TR47U

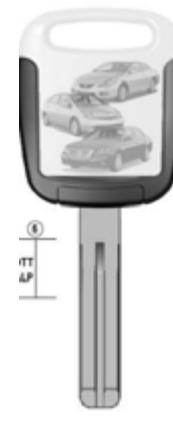

TR48U

SY2SU SSY3MH

TR41U TOY41RMH  
 TR47U TOY43MH  
 TR47SU TOY43RMH  
 TR48U TOY49MH

### TOYOTA



TR49U



TR51U



TR53U



TR56U

TR49U TOY40MH  
 TR51U TOY40MH  
 TR53U TOY49MH  
 TR56U TOY47MH

## HOEFIJZER MODELLEN

### VOLKSWAGEN VAG

### RENAULT

V35U HU49MH  
V35SU HU49RMH  
V66U HU66MH

VE20U VAC102MH  
VE25U HU136MH

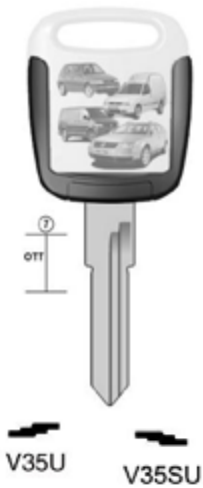

### VOLVO

### OPEL

VL17U NE66MH

VX1U HU46MH  
VX2U YM28MH  
VX3U YM27MH

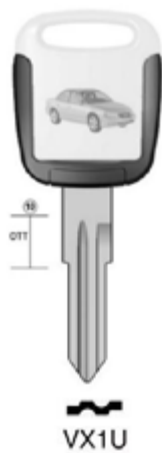







### OPEL

VX4U HU43MH  
VX5U HU100MH  
VX6U



## HOEFIJZER MODELLEN

YAMAHA		CHRYSLER		ZADI	
					YM35SU YH35RMH YM35U YH35MH Y160U CY24MH Y170U ZAD20 ZD24RMH
YM35U	YM35SU	Y160U	Y170U	ZAD20U	
ZADI					
					ZAD30U ZD30MH
ZAD30U					





























# PODSLEUTELS

## PODSLEUTELS

AUDI		ALFA ROMEO		GM	
				AD35TK	HU49BTE
				AD66TK	HU66BTE
				AR16TK	GT16TE
				B106TK	SIP16TE
					
AD35TK	AD66TK	AR16TK	NEW B106TK		
BMW		CITROEN		CHEVROLET	
				BM2TK	HU92RTE
				BM9TK	BW9TE
				CN22TK	SC9TE
				DAE47TK	DWO5TE
				DAE47STK	DWO5RTE
					
NEW BM2TK	NEW BM9TK	CN22TK	DAE47TK DAE47STK		
CHEVROLET		DAIHATSU		FORD	
				DAE48TK	DWO4TE
				DWO48STK	DWO4RTE
				FD3TK	FO21TE
					
DAE48TK' DAE48STK	NEW DAI1STK	FD3TK			

**PODSLEUTELS**

**FORD** **FIAT**



FD20TK



FD21TK



NEW FD40TK



NEW FT22TK

FD20TK FO26TE  
 FD21TK F038RTE  
 FD40TK HU101TE  
 FT22TK SIP22TE

**FIAT** **HONDA** **HYUNDAI**

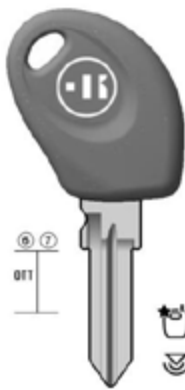

NEW FT50TK

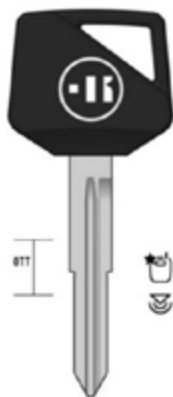

NEW HD70TK

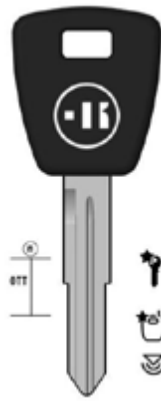

NEW HD90TK



NEW HY6TK

HD70TK HON70TE  
 HD90TK HON58RTE  
 HY6TK HYN6TE

**HYUNDAI**



NEW HY7STK



NEW HY10TK



NEW HY12TK

HY7STK HYN7RTE  
 HY10TK HYN10TE  
 HY12TK HYN12TE

PODSLEUTELS

**HYUNDAI** **ISUZU** **JAGUAR**

				HY14TK	HYN14TE
				HY14STK	HYN14RTE
				ISU5TK	ISU5TE
				JA2T	TBE1TE

**KIA** **MITSUBISHI**

				KI3STK	KIA3RTE
				MT1BTK	MT1BTK
				MT8SBK	MIT8RTE
				MT11BTK	MIT11RTE

**MITSUBISHI** **MAZDA** **NISSAN**

			MT15TK	HU56RTE
			MZ24TK	MAZ24RTE
			NS27TK	NSN11TE

PODSLEUTELS

PEUGEOT RENAULT

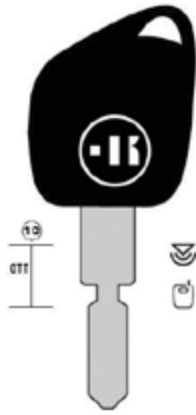

PG31TK



NEW PG33TK



NEW PG83TK



NEW RN30TK

PG31TK NE78TE  
 PG33TK VA2TE  
 PG83TK HU83TE  
 RN30TK NE73TE

ROVER SUZUKI



RV3TK



SU15TK



SU17TK

NEW SU17STK

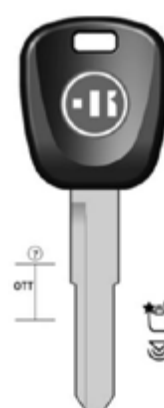

NEW SU19TK

RV3TK NE77RTE  
 SU15TK SUZ12TE  
 SU17TK SZ11RTE  
 SU17STK SZ11TE  
 SU19TK HU133TE

SUBARU SSANG SONG



SUB1TK



SUB2TK



NEW SY3STK

SUB1TE DAT17TE  
 SUB2TK NSN19TE  
 SY3STK SSSY3TE

PODSLEUTELS

TOYOTA

TR41TK	TOY41RATE
TR47TK	TOY43RTE
TR47STK	TOY43TE
TR48TK	TOY48TE
TR49TK	TOY40BTE



TR41TK

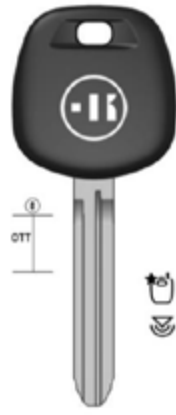

TR47TK



TR47STK

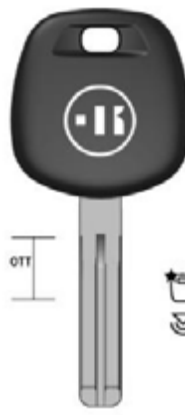

TR48TK



TR49TK

TOYOTA

VOLKSWAGEN VAG

TR51TK	TOY40TE
TR56TK	TOY47TE
V35TK	HU49TE
V35ST	HU49TE
V66TK	HU66TE



TR51TK

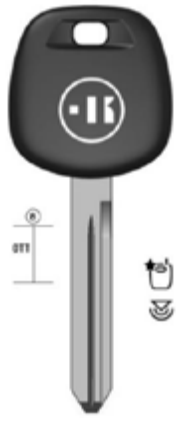

TR56TK



V35TK



V35STK



V66TK

VAG

RENAULT

VOLVO

V70TK	HU70TE
VE20TK	VAC102TE
VL10TK	NE51TE



V70TK



VE20TK



VL10TK

**PODSLEUTELS**

**VOLVO** **OPEL**



**VL15TK**



**VL17TK**



**VX1TK**



**VX2TK**

VL15TK HU56RTE  
 VL17TK NE66TE  
 VX1TK HU46TE  
 VX2TK YM28TE  
 VX3TK YM27TE

**VX3TK**

**OPEL** **MERCEDES**



**VX4TK**



**VX5BTK**



**VX6BT**

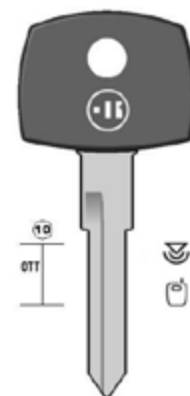

**YS15TK**

VX4TK HU43TE  
 VX5BTK HU100TE  
 VX6BTK  
 YS15T YM15TE

**CHRYSLER**



**Y159TK**

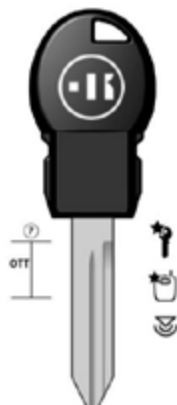

**Y170TK**

Y159TK CY24TE  
 Y170TK Y-160-PT







## HERLEIDINGEN KEYLINE - SILCA

## HERLEIDING KEYLINE - SILCA

KEYLINE	SILCA	KEYLINE	SILCA	KEYLINE	SILCA	KEYLINE	SILCA
AB1P	AY1P	ABU89	AB89	BE4D	BE200	CA21	CS38
ABS3	KEY1	ABU8S	AB3R	BE5D	BE202	CA3D	CS4
ABS3S	KEY1R	ABU95	AB95	BH1	BH4	CA40D	CS120
ABU1	AB1	ABU96	AB89	BK1	BK1	CA41D	CS119
ABU12P	AB38P	AD35P	HU49P	BK12S	BK30	CA43	CA43
ABU13	AB13	AGB1	AGB5	BK15	BK15	CA48	CS48
ABU163	AB63	AGB6	AGB6	BK16	BK16	CA4D	CS204
ABU17	AB17	AKS10	AKR10	BK2S	BK26	CA4PD	CS6
ABU17S	AB17R	AKS16S	AKR16R	BMB3	BMB3	CA4PS	CS6R
ABU18	AB18	AKS1S	AKR1R	BMB5	BMB5	CA50D	CS17
ABU19-A	AB36	AKS2	AKR2	BMC1	MSF1	CA57	CS145
ABU1-A	AB1X	AKS4	AKR4	BO2	BO2	CA5D	CS206
ABU1S	AB1R	AKS7	AKR7	BRA2S	MAR1	CA5PD	CS7
ABU2	AB12	AKS8	AKR8	BSC2	BSC2	CA5PS	CS7R
ABU21	AB102	ALP4	ALP4	BT2	BT2	CA5S	CS207
ABU22-T	AB76	ALP4S	ALP4R	BT4	BT4	CA60	CS146
ABU3	AB14	ALP9	ALP9	BT5	BT5	CA62	CS62
ABU32	AB52	ALP9S	ALP9R	BU1	BUR2	CA62P	CS62P
ABU35S	AB54	ARM1S	ART1R	BU10	BUR29	CA83	CS83
ABU36	AB91	AS20	ASS31	BU10S	BUR29R	CA85	CS85
ABU39	AB19	AS28N	ASS2	BU11	BUR62	CAB1	CAB1
ABU43	AB43	AS29NN	ASS44	BU16	BUR13	CAB2S	CAB2R
ABU43S	AB43R	AS34E	ASS40	BU2	BUR1	CAS10	CIS12
ABU47	AB77	AS37HH	ASS52R	BU23	BUR23	CAS18-ST	SN5R
ABU48	AB48	AXA12	AXA12	BU23S	BUR23R	CAS2PD	CIS2
ABU49	AB62	AXA1BP	AX8RBP	BU28S	BUR28R	CAS30-ST	CIS12X
ABU52	AB15	AXA1P	AX7RAP	BU3	BUR20	CAS50D	NOXXA
ABU53	AB53	AXA2P	AX4RP	BU31	BUR31	CAS3PD	CIS3
ABU57P	AB57AP	AXA3P	AX1RP	BU31S	BUR31R	CAS4D	CIS6
ABU57SP	AB57RAP	AXA3SBLP	AX1RP	BU38	BUR38	CAS4PD	CIS4
ABU59S	AB83	AXA3SBP	AX1RP-XL	BU3S	BUR20R	CAS5D	CIS5
ABU6	AB2	AXA3SP	AX1RP-X	BU4	BUR21	CAX1S	CAX1R
ABU60S	AB86	AXA4P	ASS96P	BU4S	BUR21R	CAX2S	CAX2R
ABU61S	AB61	AXA4SP	ASS96RP	BU5S	BUR24R	CEM1	CM2
ABU65SP	AB65RAP	AXA5SP	AX5RP	BU6	BUR34R	CHU6	CHU6
ABU66SP	AB66R	AXA6P	AX9CP	BU61	BUR61	CHV1	CHV1
ABU67SP	AB58RAP	BA1	BAI1	BUVA3	BVA3	CHV1S	CHV1R
ABU68SP	AB59RAP	BA11		CA13D	CS13	CHV2-A	CHV2
ABU74	AB74	BA8S		CA144	CS144	CIN3S	RC3R
ABU7P	AB82RAP	BB10S	BB13R	CA18	CS32	CIN5	RC5
ABU8	AB3	BB10	BB13	CA18S	CS32R	CIN5S	RC5R
ABU82P	T82/T83	BD11S	BD6R	CA19S	CS33R	CLA2S	CR2R

## HERLEIDING KEYLINE - SILCA

KEYLINE	SILCA	KEYLINE	SILCA	KEYLINE	SILCA	KEYLINE	SILCA
CN22CP	SX9CP	DO12	DM17	EV30	EVVA GPI	GM4	GM7
COR11S	CB11R	DO120	DM120	EV3KS-203	EV3KS	GNT1P	GNT1P
COR40D	CB2	KOFFER VC	DM17R	EV3KS-203	EV3KS	GO13	GL13R
COR4PD	CB4	DO14	DM14	EV3KS-204	EV3KS	HD35BP	
COR50D	CB1	DO15	DM16	EV5-A	EV3	HD73P	KYM4P
COR51PD	CB15	DO150	DM65-HS	EV69-A	EV69RX	HD73SP	KYM4RP
COR5D	CB5	DO150S	DM65R-HS	EVD2	ED4	HE1	HN3
COR5PD	CB3	DO16	DM15	EVD3	ED3	HE2	HN1
COR68	CB85	DO20	DM11	EVD3S	ED3R	HE4	HN4
COR6D	CB6	DO21	DM25	EVD4	ED2	HE7	HN7
COR6S	CB6R	DO220	DM119	EVD5	ED4	HFL1	HF75R
COR78S	CB78R	DO27	DM27	FARM2S	FAR2R	HFL1S	HF75
COR80	CB80	DO39S	DM39R	FB1-100X	FB21RX	HFL3	HF74R
CS100	CE155	DO55S	DM154R	FB2-320	FB20RX	HL2	HW4
CRN1	COR1	DO55	DM154	FB2-300	FB19RX	HL1	HW1
CS114	CE114	DO8	DM8	FD11	FO14R	HL3S	HW15R
CS13	CE7	DO8S	DM8R	FF2	FF1	HO1S	HO2R
CS131	CE131	DO9S	DM19	FF5	FF2	HOP1	HPP1R
CS148-A	CE148	DS2	DS4	FOR1S	FRT4R	HOP1S	HPP1
CS15	CS147	ELZ1	EL1	FOR2S	FRT5R	HR1	HR1
CS158S	CE158	EMK1	EMK1	FOR3	FRT8	HS1	HS1
CS16-T	CE16	EPK1P	STH1RP	FT1505GP	GT15RDP	HS1S	HS1R
CS17WPS	CE17WPS	EPK1SP		FT8	AF7A	HUN5	HUT1
CS17XPS	CE17XPS	EU10	EU10	FTH10	FH13	IC1	LC14R
CS18	CE18	EU10S	EU10R	FTH11	FH11	IC5	ICS1
CS20X	KB LOPER	EU11S	EU11R	FTH12	FH12	IF6	IF6
CS2A	CE2X	EU12	EU12	FTH23S	FH23R	IL1S	IL1
CS3	CE1	EU13S	EU13R	FV2	KV2	ISE14	IE14
CS4	CE4	EU14S	EU14	GB1S	GBS1	ISE15	IE15
CS41	CE41	EU16S	EU16R	GG2	GE2	ISE15P	IE15P
CS42-ST	CE20/CE127	EU18	EU18R	GHE1	GHE1	ISE17	IE26
CS50S	CE14PS	EU56	LF57	GHE2	GHE2	ISE2	IE2
CV3	CVL3	EU8	EU17	GIS2PD	GS13	ISE27S	IE27R
CY2S	CA2	EV10-A	EV10X	GIS4	GS4	ISE29	IE29
DK6	DK6	EV11-A	EVVA-NLFG	GIS4S	GS4R	ISE30	IE30
DO100X	DM139	EV12-A	EVVA-NLGG	GIS5PD	SM1R	ISE31	IE31
DO102X	DM	EV13-A	EVVA-NLKG	GIS5PS	SM1	ISE4D	IE7
DO105S	DM151R	EV14-A	EVVA-NLO	GM1	GM1	ISE5D	IE6
DO11	DM10	EV15-A	EV3X	GM2	GM5	ISE5SM	IE9
DO110	DM110	EV21S-A	EVVA-TSC	GM3	GM2	JG1S	JR1R

## HERLEIDING KEYLINE - SILCA

KEYLINE	SILCA	KEYLINE	SILCA	KEYLINE	SILCA	KEYLINE	SILCA
JM3S	JM3	LF12S	LF8	LI7	LP7	MLS9	ME9
JOW12-A	JOW12X	LF14S	LF45R	LI7S	LP7R	MN9	MG8
JU1	JU11	LF18	LF36	LI8	LP8	MRT1S	MRT1R
JU1S	JU11R	LF19	LF19	LI8S	LP8R	MST10	MS10
JU2S	JU13R	LF19S	LF19R	LIN12	LC2	MST19	MS19
JU3	JU12	LF1S	EU1R	LIN15	LC15	MST20	MS20
JUN1	JU1	LF20S	LF31R	LIN2S	LC2R	MST2S	MS3
JUN2	JU2	LF23R	LF23R	LIT1S	LT2	MZ20P	MAZ20REP
K1	KS1	LF24	LF22	LIT2	LT5	NE5	NE5
KAW15P	KW15BP	LF24S	LF22R	LIT3-T	LT3	NF20S	NME1R
KAW16P	KW14AP	LF25	LF16	LIT4	LT4	NF21S	NME2R
KE1	KLE1	LF25S	LF16R	LIT6S	LT6R	NF22S	NME4R
KE10S	KE10	LF26	LF26R	LKW11	LW14	NU4	NS4
KE4	KLE4	LF27S	LF58R	LOB1S	LOB1	OJ12S	OJ12
KE7	KLE7X	LF28S	LF59R	LR4	LH3	OJ17S	OJ17R
KE7S	KLE7RX	LF31	LF39	MA15S	MAU5R	OJ6	OJ6R
KL109	GO6	LF32	LF27	MA1S	DK1	OJ7	OJ7R
KM13	KI13	LF3S	EU5R	MA3S	MAU1R	OM1	OM1
KS1	KE1	LF4S	EU3	MC1	MC2	PFA1S	PHF2R
KS13X	KE19	LF5	LF12	MC12	MC12	PFA22S	PHF22R
KS2	KE3	LF56	LF56	MC15S	MC15R	PFA2S	PHF19
KS2X	KE19	LF6	LF26	MC1S	MC2R	PFA3S	PHF1R
KS3	KE9	LF60	LF60	MCH7S	OMR1R	PFA4S	PHF17
KV1	KF1	LF61S	LF61R	ME17T	MER22T	PFA6S	PHF16R
KYM1P	KYM1P	LF7	EU4	ME18T	MER25T	PFA7S	PHF18R
KYM1SP	KYM1RP	LF7S	EU4R	ME34	MER34R	PFA8	PHF26R
KYM2P	KYM2P	LF85	LF4	ME35	MER35R	PFA8S	PHF26
KYM2SP	KYM2RP	LF85S	LF4R	ME40PD	MER2	PFA9	PHF27
KYM3P	KYM3P	LF87	LF2	ME41PD	MER1	PFA9S	PHF27R
KYM3SP	KYM3RP	LF88	EU19	ME42PD	MER4	PG32P	NE74P
LAS1	LS1	LI11	LP11	ME42PS	MER4R	PGO1P	PGO2P
LAS11	LS14	LI12	LP12	ME5D	MER8	POT1S	PT1
LAS11S	LS14R	LI12S	LP12R	MEF1S	MF1R	PR1D	PF1
LAS3S	LS11R	LI13	LP13	MGN1SP	MGN1RP	PR5SM	PF092
LAS3	LS11	LI13S	LP13R	ML13P	MTK13RAP	RD1	RD1
LAS5	LS7	LI2	LP2	ML41P	MTK	RD2	RD2
LAS7	LS9	LI21S	LP21R	ML4P	MTK4RP	RI10	RO4
LAS7S	LS9R	LI21	LP21	ML6P	MTK9RP	RI10S	RO4R
LAS9	LS13	LI2S	LP2R	ML7P	ML7P	RI11	RO21
LAS9S	LS13R	LI3	LP3R	ML8P	ML8P	RI11S	RO21R
LF11	LF11	LI3S	LP3	MLM1	MLM1	RI17S	RO69
LF11S	LF11R	LI6S	LP57R	MLM1S	MLM1R	RI18	RO41

## HERLEIDING KEYLINE - SILCA

KEYLINE	SILCA	KEYLINE	SILCA	KEYLINE	SILCA	KEYLINE	SILCA
RI19	RO67R	TES17	TE19	VC4	VAC14	YE2	YA14
RI19S	RO67	TES19	TE19	VC8	VAC48	YE2S	YA14R
RI2	RO20	TES2	TE2	VR20	VI4	YE3S-T	YA2R
RI20	RO68	TES3	TE3	VR4PD	VI084	YE3-T	YA2
RI20S	RO68R	TES4	TES5	VR4PS	VI085	YE4D	YA6
RI21	RO77	TES5	TE2	VR5D	VI080	YE4PD	YA13
RI2S	RO20R	TES6	TE6	VR5PD	VI086	YE4PS	YA13R
RI3	RO8	TES8	EC5	VR5PS	VU087	YE50	YA5
RK1	RU1	TK1	TO1	VR5S	VI081	YE51S	YA1R
RK14	RU14	TK10SL	TO120RX	VR7S	VI7R	YE51	YA1
RN30PL	NE73P	TK1-A	TO1X	VS9	VS090	YE5D	YA226
RZ1	REN1	TOP1S-ST	TOP1R	WA1	WA1	YE5PD	YA7
RZ10	REN6R	TR42	TOY38R	WAN1	WGU1	YE6D	YA31
RZ1S	REN1R	TRK1P	TRK1P	WI100	WK62R	YE6S	YE31R
RZ2	REN2	TRK2P	TRK6P	WI1A	WK1X	YE7	YA4
RZ2S	REN2R	TRK3P	TRK7P	WI2	WK55	YE70S	YA70
RZ3S	REN3R	TRK4P	TRK8DP	WI36	WK70	YE7S	YA4R
RZ4S	REN4R	TRK5P	TRK11DP	WI50		YE8	YA3
S1S	SI1R	TV4	TR1	WI59S-A	WK59R	YE91	YE91
S4S	SI4R	UM1S	UC1R	WK4D	WE13	YET1	YT1
SAT1-A	STU1	UN3PD	UL056	WK5S	WE1R	YET15	YT15
SPA3S	SSA3R	UN4D	UL052	WR2-T	WEI2	YET1S	YT1R
SPA4S	SSA4R	UN4PD	UL060	WR7	WEI1	YM10P	YH30P
SPA4SP	SSA4RP	UN4S	UL053	WS2	WEI5	YM10SP	YH30RP
SPA5S	SSA5R	UN5D	UL050	WY5D	WA1	YM8P	YH28P
ST2S	STL2R	UN5PD	UL058	XBU1P	XBW1P	YM8SP	YH28RP
STA10	STA10	UN5PS	UL059	XBU2P	XBW2P	YM9P	YH29P
STA10S	STA10R	UN5S	UL051	XFIA2P	XF2P	YM9SP	YH29RP
STR1SP	STY1P	UN6D	UL054	XI1	IEH1	YMS1P	YW1P
STS1	STS1	UN6S	UL055	XNF1P	XN1	ZAD11P	ZD9P
STS6S	STS6	UN7D	UL046	XNF2P	XN2	ZAD14P	ZD16RP
SU14SP	SZ10RP	UNI1	UNI8	XYE1P	XY4P	ZAD16P	ZD14RP
TC2D	TL7	UNI2	UNI11A	XZA1P	ZAS1P	ZAD18P	ZD23RCP
TC2S	TL7R	UNKB2	UNI3	XYE1P	XY4P	ZAD19SAP	ZD22RBP
TC3D	TL6	V13P	VO13P	XZA1P	ZAS1P	ZAD20P	ZD24RDP
TC3S	TL6R	V66P	HU66P	XZI1P	XZ1A	ZAD25	ZD25
TC5D	TL1	VC1	VAC1	XZI2P	XZ2A	ZAD26	ZD20
TC5S	TL1R	VC11	VAC46	XZI3P	XZ3A	ZAD27P	ZD17RAP
TC60D	TL2	VC14S	VAC25	YE11	YE35	ZI14-A	ZE12X
TC60S	TL2R	VC25	VAC29	YE12	YA89	ZI2	ZE1
TC61D	TL3	VC26	VAC151	YE14	YA18	ZI2S-A	ZE1X
TC61S	TL3R	VC2	VAC2	YE14S	YA18R	ZI3	ZE2
TC9D	TL	VC39	VAC61	YE15	YA8	ZI6	ZE6
						ZI6S	ZE6R





## HERLEIDINGEN SILCA - KEYLINE

## HERLEIDING SILCA - KEYLINE

SILCA	KEYLINE	SILCA	KEYLINE	SILCA	KEYLINE	SILCA	KEYLINE
AB1	ABU1	AF7A	FT8	BK16	BK16	CB5	COR5D
AB12	ABU2	AGB5	AGB1	BK26	BK2S	CB6	COR6D
AB13	ABU13	AGB6	AGB6	BK30	BK12S	CB6R	COR6S
AB14	ABU3	AKR10	AKS10	BMB3	BMB3	CB78R	COR78S
AB15	ABU52	AKR16R	AKS16S	BMB5	BMB5	CB80	COR80
AB17	ABU17	AKR1R	AKS1S	BO2	BO2	CB83	COR83
AB17R	ABU17S	AKR2	AKS2	BSC2	BSC2	CB85	COR68
AB18	ABU18	AKR4	AKS4	BT2	BT2	CE1	CS3
AB19	ABU39	AKR7	AKS7	BT4	BT4	CE114	CS114
AB1R	ABU1S	AKR8	AKS8	BT5	BT5	CE131	CS131
AB1X	ABU1-A	ALP4	ALP4	BUR1	BU2	CE148	CS148-A
AB2	ABU6	ALP4R	ALP4S	BUR13	BU16	CE14PS	CS50S
AB3	ABU8	ALP9	ALP9	BUR2	BU1	CE155	CS100
AB36	ABU19-A	ALP9R	ALP9S	BUR20	BU3	CE158	CS158S
AB38P	ABU12P	ART1R	ARM1S	BUR20R	BU3S	CE16	CS16-T
AB3R	ABU8S	ASS2	AS28N	BUR21	BU4	CE17WPS	CS17WPS
AB43	ABU43	ASS31	AS20	BUR21R	BU4S	CE17XPS	CS17XPS
AB43R	ABU43S	ASS40	AS34E	BUR23	BU23	CE18	CS18
AB48	ABU48	ASS44	AS29NN	BUR23R	BU23S	CE20/CE127	CS42-ST
AB52	ABU32	ASS52R	AS37HH	BUR24R	BU5S	CE2X	CS2A
AB53	ABU53	ASS96P	AXA4P	BUR28R	BU28S	CE4	CS4
AB54	ABU35S	ASS96RP	AXA4SP	BUR29	BU10	CE41	CS41
AB57AP	ABU57P	AX1RP	AXA3P	BUR29R	BU10S	CE6	CS11
AB57RAP	ABU57SP	AX1RP	AXA3SBLP	BUR31	BU31	CE7	CS13
AB58RAP	ABU67SP	AX1RP-X	AXA3SP	BUR31R	BU31S	CHU6	CHU6
AB59RAP	ABU68SP	AX1RP-XL	AXA3SBP	BUR34R	BU6	CHV1	CHV1
AB61	ABU61S	AX4RP	AXA2P	BUR38	BU38	CHV1R	CHV1S
AB62	ABU49	AX5RP	AXA5SP	BUR61	BU61	CHV2	CHV2-A
AB63	ABU163	AX7RAP	AXA1P	BUR62	BU11	CIS12	CAS10
AB65RAP	ABU65SP	AX8RBP	AXA1BP	BVA3	BUVA3	CIS12X	CAS30-ST
AB66R	ABU66SP	AX9CP	AXA6P	CA2	CY2S	CIS2	CAS2PD
AB74	ABU74	AXA12	AXA12	CA43	CA43	CIS3	CAS3PD
AB102	ABU21	AY1P	AB1P	CAB1	CAB1	CIS4	CAS4PD
AB76	ABU22-T	BAI1	BA1	CAB2R	CAB2S	CIS5	CAS5D
AB77	ABU47	BB13	BB10	CAX1R	CAX1S	CIS6	CAS4D
AB82RAP	ABU7P	BB13R	BB10S	CAX2R	CAX2S	CM2	CEM1
AB83	ABU59S	BD6R	BD11S	CB1	COR50D	COR1	CRN1
AB86	ABU60S	BE200	BE4D	CB11R	COR11S	CR2R	CLA2S
AB89	ABU89	BE202	BE5D	CB15	COR51PD	CS119	CA41D
AB89	ABU96	BH4	BH1	CB2	COR40D	CS120	CA40D
AB91	ABU36	BK1	BK1	CB3	COR5PD	CS13	CA13D
AB95	ABU95	BK15	BK15	CB4	COR4PD	CS144	CA144



## HERLEIDING SILCA - KEYLINE

SILCA	KEYLINE	SILCA	KEYLINE	SILCA	KEYLINE	SILCA	KEYLINE
CS145	CA57	DM3	DO5	EVVA-NLO	EV14-A	HPP1R	HOP1
CS146	CA60	DM39R	DO39S	EVVA-TSC	EV21S-A	HR1	HR1
CS147	CS15	KOFFER VOO	DO63	FAR2R	FARM2S	HS1	HS1
CS17	CA50D	DM65-HS	DO150	FB19RX	FB2-300	HS1R	HS1S
CS204	CA4D	DM65R-HS	DO150S	FB20RX	FB2-320	HU49P	AD35P
CS206	CA5D	DM8	DO8	FB21RX	FB1-100X	HU66P	V66P
CS207	CA5S	DM8R	DO8S	FB28RX	FB1-140X	HUT1	HUN5
CS32	CA18	DS4	DS2	FF1	FF2	HW1	HL1
CS32R	CA18S	EC5	TES8	FF2	FF5	HW15R	HL3S
CS33R	CA19S	ED2	EVD4	FH11	FTH11	HW4	HL2
CS38	CA21	ED3	EVD3	FH12	FTH12	HW4R	HL2S
CS4	CA3D	ED3R	EVD3S	FH13	FTH10	ICS1	IC5
CS48	CA48	ED4	EVD2	FH23R	FTH23S	IE14	ISE14
CS62P	CA62P	EMK1	EMK1	FRT5R	FOR2S	IE2	ISE2
CS62	CA62	EL1	ELZ1	FRT4R	FOR1S	IE15P	ISE15P
CS7	CA5PD	EU10R	EU10S	GBS1	GB1S	IE27R	ISE27S
CS7R	CA5PS	EU11R	EU11S	GE2	GG2	IE29	ISE29
CS83	CA83	EU12	EU12	GHE1	GHE1	IE30	ISE30
CS85	CA85	EU13R	EU13S	GHE2	GHE2	IE31	ISE31
CVL3	CV3	EU14	EU14S	GL13R	GO13	IE6	ISE5D
DK1	MA1S	EU16R	EU16S	GM1	GM1	IE7	ISE4D
DK6	DK6	EU17	EU8	GM2	GM3	IE9	ISE5SM
DM	DO102X	EU18R		GM5	GM2	IEH1	XI1
DM10	DO11	EU19	LF88	GM7	GM4	IF6	IF6
DM11	DO20	EU1R	LF1S	GNT1P	GNT1P	IL1	IL1S
DM110	DO110	EU3	LF4S	GO6	KL109	JM3	JM3S
DM119	DO220	EU4	LF7	GS13	GIS2PD	JOW12X	JOW12-A
DM120	DO120	EU4R	LF7S	GS4	GIS4	JR1R	JG1S
DM139	DO100X	EU5R	LF3S	GS4R	GIS4S	JU1	JUN1
DM14	DO14	EV10X	EV10-A	GT15RDP	FT1505GP	JU11	JU1
DM15	DO16	EV3	EV5-A	HF74	HFL3S	JU11R	JU1S
DM151R	DO105S	EV3KS	EV3KS-203B	HF74R	HFL3	JU12	JU3
DM154	DO55	EV3KS	EV3KS-203C	HF75	HFL1S	JU13R	JU2S
DM154R	DO55S	EV3KS	EV3KS-204	HF75R	HFL1	JU2	JUN2
DM16	DO15	EV3X	EV15-A	HN1	HE2	KB LOPER	CS20X
DM17	DO12	EV69RX	EV69-A	HN3	HE1	KE1	KS1
DM17R	DO12S	EVVA GPI	EV30	HN4	HE4	KE10	KE10S
DM19	DO9S	EVVA-NLFG	EV11-A	HN7	HE7	KE19	KS13X
DM25	DO21	EVVA-NLGG	EV12-A	HO2R	HO1S	KE19	KS2X
DM27	DO27	EVVA-NLKG	EV13-A	HPP1	HOP1S	KE3	KS2

## HERLEIDING SILCA - KEYLINE

SILCA	KEYLINE	SILCA	KEYLINE	SILCA	KEYLINE	SILCA	KEYLINE
KE9	KS3	LF4	LF85	LT6R	LIT6S	NME4R	NF22S
KEY1	ABS3	LF45R	LF14S	LW14	LKW11	NOXXA	CAS50D
KEY1R	ABS3S	LF4R	LF85S	MAR1	BRA2S	NS4	NU4
KF1	KV1	LF56	LF56	MAU1R	MA3S	OJ12	OJ12S
KI13	KM13	LF57	EU56	MAU5R	MA15S	OJ17R	OJ17S
KLE1	KE1	LF58R	LF27S	MAZ20REP	MZ20P	OJ6R	OJ6
KLE4	KE4	LF59R	LF28S	MC12	MC12	OJ7R	OJ7
KLE7RX	KE7S	LF60	LF60	MC15R	MC15S	OM1	OM1
KLE7X	KE7	LF61R	LF61S	MC2	MC1	OMR1R	MCH7S
KS1	K1	LF8	LF12S	MC2R	MC1S	PF092	PR5SM
KV2	FV2	LH3	LR4	ME9	MLS9	PF1	PR1D
KW14AP	KAW16P	LOB1	LOB1S	MER1	ME41PD	PGO2P	PGO1P
KW15BP	KAW15P	LP11	LI11	MER2	ME40PD	PHF16R	PFA6S
KYM1P	KYM1P	LP12	LI12	MER22T	ME17T	PHF17	PFA4S
KYM1RP	KYM1SP	LP12R	LI12S	MER25T	ME18T	PHF18R	PFA7S
KYM2P	KYM2P	LP13	LI13	MER34R	ME34	PHF19	PFA2S
KYM2RP	KYM2SP	LP13R	LI13S	MER35R	ME35	PHF1R	PFA3S
KYM3P	KYM3P	LP2	LI2	MER4	ME42PD	PHF22R	PFA22S
KYM3RP	KYM3SP	LP21	LI21	MER4R	ME42PS	PHF26	PFA8S
KYM4P	HD73P	LP21R	LI21S	MER8	ME5D	PHF26R	PFA8
KYM4RP	HD73SP	LP2R	LI2S	MF1R	MEF1S	PHF27	PFA9
LC14R	IC1	LP3	LI3S	MGN1RP	MGN1SP	PHF27R	PFA9S
LC15	LIN15	LP3R	LI3	ML7P	ML7P	PHF2R	PFA1S
LC2	LIN12	LP57R	LI6S	ML8P	ML8P	PT1	POT1S
LC2R	LIN2S	LP7	LI7	MLM1	MLM1	RC3R	CIN3S
LF11	LF11	LP7R	LI7S	MLM1R	MLM1S	RC5	CIN5
LF11R	LF11S	LP8	LI8	MN	MN9	RC5R	CIN5S
LF12	LF5	LP8R	LI8S	MRT1R	MRT1S	RD1	RD1
LF16	LF25	LS1	LAS1	MS10	MST10	RD2	RD2
LF16R	LF25S	LS11	LAS3	MS19	MST19	REN1	RZ1
LF19	LF19	LS11R	LAS3S	MS20	MST20	REN1R	RZ1S
LF19R	LF19S	LS13	LAS9	MS3	MST2S	REN2	RZ2
LF2	LF87	LS13R	LAS9S	MSF1	BMC1	REN2R	RZ2S
LF22	LF24	LS14	LAS11	MTK	ML41P	REN3R	RZ3S
LF22R	LF24S	LS14R	LAS11S	MTK13RAP	ML13P	REN4R	RZ4S
LF23R	LF23R	LS7	LAS5	MTK4RP	ML4P	REN6R	RZ10
LF26	LF6	LS9	LAS7	MTK9RP	ML6P	RO20	RI2
LF26R	LF26	LS9R	LAS7S	NE5	NE5	RO20R	RI2S
LF27	LF32	LT2	LIT1S	NE73P	RN30PL	RO21	RI11
LF31R	LF20S	LT3	LIT3-T	NE74P	PG32P	RO21R	RI11S
LF36	LF18	LT4	LIT4	NME1R	NF20S	RO4	RI10
LF39	LF31	LT5	LIT2	NME2R	NF21S	RO41	RI18

## HERLEIDING SILCA - KEYLINE

SILCA	KEYLINE	SILCA	KEYLINE	SILCA	KEYLINE	SILCA	KEYLINE
RO4R	RI10S	<b>TL3</b>	TC61D	<b>VI084</b>	VR4PD	<b>YA31</b>	YE6D
RO67	RI19S	<b>TL3R</b>	TC61S	<b>VI085</b>	VR4PS	<b>YA4</b>	YE7
RO67R	RI19	<b>TL6</b>	TC3D	<b>VI086</b>	VR5PD	<b>YA4R</b>	YE7S
RO68	RI20	<b>TL6R</b>	TC3S	<b>VI4</b>	VR20	<b>YA5</b>	YE50
RO68R	RI20S	<b>TL7</b>	TC2D	<b>VI7R</b>	VR7S	<b>YA6</b>	YE4D
RO69	RI17S	<b>TL7R</b>	TC2S	<b>VO13P</b>	V13P	<b>YA7</b>	YE5PD
RO77	RI21	<b>TO1</b>	TK1	<b>VS090</b>	VS9	<b>YA70</b>	YE70S
RO8	RI3	<b>TO120RX</b>	TK10SL	<b>VU087</b>	VR5PS	<b>YA8</b>	YE15
RU1	RK1	<b>TOP1R</b>	TOP1S-ST	<b>WA1</b>	WA1	<b>YA89</b>	YE12
RU14	RK14	<b>TO1X</b>	TK1-A	<b>WA1</b>	WY5D	<b>YE31R</b>	YE6S
SI1R	S1S	<b>TOY38R</b>	TR42	<b>WE13</b>	WK4D	<b>YE35</b>	YE11
SI4R	S4S	<b>TR1</b>	TV4	<b>WE1R</b>	WK5S	<b>YE91</b>	YE91
SM1	GIS5PS	<b>TRK11DP</b>	TRK5P	<b>WE11</b>	WR7	<b>YH28P</b>	YM8P
SM1R	GIS5PD	<b>TRK1P</b>	TRK1P	<b>WE12</b>	WR2-T	<b>YH28RP</b>	YM8SP
SN5R	CAS18-ST	<b>TRK6P</b>	TRK2P	<b>WE15</b>	WS2	<b>YH29P</b>	YM9P
SSA3R	SPA3S	<b>TRK7P</b>	TRK3P	<b>WGU1</b>	WAN1	<b>YH29RP</b>	YM9SP
SSA4R	SPA4S	<b>TRK8DP</b>	TRK4P	<b>WK1X</b>	WI1A	<b>YH30P</b>	YM10P
SSA4RP	SPA4SP	<b>UC1R</b>	UM1S	<b>WK55</b>	WI2	<b>YH30RP</b>	YM10SP
SSA5R	SPA5S	<b>UL046</b>	UN7D	<b>WK59R</b>	WI59S-A	<b>YT1</b>	YET1
STA10	STA10	<b>UL050</b>	UN5D	<b>WK62R</b>	WI100	<b>YT15</b>	YET15
STA10R	STA10S	<b>UL051</b>	UN5S	<b>WK70</b>	WI36	<b>YT1R</b>	YET1S
STH1P	EPK1SP	<b>UL052</b>	UN4D	<b>XBW1P</b>	XBU1P	<b>YW1P</b>	YMS1P
STH1RP	EPK1P	<b>UL053</b>	UN4S	<b>XBW2P</b>	XBU2P	<b>ZAS1P</b>	XZA1P
STL2R	ST2S	<b>UL054</b>	UN6D	<b>XF2P</b>	XFIA2P	<b>ZD14RP</b>	ZAD16P
STS1	STS1	<b>UL055</b>	UN6S	<b>XN1</b>	XNF1P	<b>ZD16RP</b>	ZAD14P
STS6	STS6S	<b>UL056</b>	UN3PD	<b>XN2</b>	XNF2P	<b>ZD17RAP</b>	ZAD27P
STU1	SAT1-A	<b>UL058</b>	UN5PD	<b>XY4P</b>	XYE1P	<b>ZD20</b>	ZAD26
STY1P	STR1SP	<b>UL059</b>	UN5PS	<b>XZ1A</b>	XZI1P	<b>ZD22RBP</b>	ZAD19SAP
SX9CP	CN22CP	<b>UL060</b>	UN4PD	<b>XZ2A</b>	XZI2P	<b>ZD23RCP</b>	ZAD18P
SZ10RP	SU14SP	<b>UNI11A</b>	UNI2	<b>XZ3A</b>	XZI3P	<b>ZD24RDP</b>	ZAD20P
T82/T83	ABU82P	<b>UNI3</b>	UNKB2	<b>YA1</b>	YE51	<b>ZD25</b>	ZAD25
TE19	TES17	<b>UNI8</b>	UNI1	<b>YA13</b>	YE4PD	<b>ZD9P</b>	ZAD11P
TE19	TES19	<b>VAC1</b>	VC1	<b>YA13R</b>	YE4PS	<b>ZE1</b>	ZI2
TE2	TES2	<b>VAC14</b>	VC4	<b>YA14</b>	YE2	<b>ZE12X</b>	ZI14-A
TE2	TES5	<b>VAC151</b>	VC26	<b>YA14R</b>	YE2S	<b>ZE1X</b>	ZI2S-A
TE3	TES3	<b>VAC2</b>	VC2	<b>YA18</b>	YE14	<b>ZE2</b>	ZI3
TE6	TES6	<b>VAC25</b>	VC14S	<b>YA18R</b>	YE14S	<b>ZE6</b>	ZI6
TES5	TES4	<b>VAC29</b>	VC25	<b>YA1R</b>	YE51S		
TL	TC9D	<b>VAC46</b>	VC11	<b>YA2</b>	YE3-T		
TL1	TC5D	<b>VAC48</b>	VC8	<b>YA226</b>	YE5D		
TL1R	TC5S	<b>VAC61</b>	VC39	<b>YA2R</b>	YE3S-T		
TL2	TC60D	<b>VI080</b>	VR5D	<b>YA3</b>	YE8		
TL2R	TC60S	<b>VI081</b>	VR5S	<b>YE15</b>	YA8		

## HERLEIDING HOEIJZERSLEUTELS

KEYLINE	SILCA	KEYLINE	SILCA	KEYLINE	SILCA
AR16U	GT16MH	HU92RMH	BM2U	TR56U	TOY47MH
AR20U	SIP16RMH	HYN10MH	HY10U	V35U	HU49MH
B106U	B111-PT	HYN12MH	HY12U	V35SU	HU49RMH
BM2U	HU92RMH	HYN14MH	HY14U	V66U	HU66MH
BM9U	BW9MH	HYN14RH	HY14SU	VE20U	VAC102MH
CN22U	SX9MH	HYN17MH	HY21U	VE25U	HU136MH
DAE47U	DWO5MH	HYN17RMH	HY21SU	VL17U	NE66MH
DAE47SU	DW05RMH	HYN6MH	HY6U	VX1U	HU46MH
DAE48U	DWO4MH	HYN7RMH	HY7SU	VX2U	YM28MH
DAE48SU	DWO4RMH	ISU5MH	ISU5U	VX3U	YM27MH
DAE49U	DWO6MH	KIA3RMH	KI3SU	VX4U	HU43MH
DAI1SU	DH4RMH	KW16MH	KAW12SU	VX5U	HU100MH
FD3U	FO21MH	MAZ24RMH	MZ24U	VX6U	VX
FD20U	F026MH	MIT	MT1U		
FD21U	FO38RMH	MIT11RMH	MT11U		
FD40U	HU101MH	MIT8RMH	MT8SU		
FT22U	SIP22MH	NE38MH	RV4U		
FT50U	GT10MH	NE73MH	RN30U		
FT1505U	GT15RMH	NE78MH	PG31U		
HD1U	HON66MH	NSN11MH	NS27U		
HD70U	HON70MH	NSN14MH	NS34U		
HD71U	HON63MH	NSN19MH	SUB2U		
HD72U	HON58RMH	SIP16RMH	AR20U		
HD90U	HON58RMH	SIP22MH	FT22U		
HU71U	HU71MH	SSY3MH	SY2SU		
HU162U	HU162MH	SU11MH	SU17SU		
HU163SU	VAG	SU11RMH	SU17U		
HY6U	HYN6MH	SX9MH	CN22U		
HY7SU	HYN7RMH	SZ12RMH	SU15U		
HY10U	HYN10MH	SZ13RMH	SU13SU		
HY12U	HYN12MH	SZ17RMH	SU14SU		
HY14U	HYN14MH	SZ17RMH	SU21U		
HY14SU	HYN14RH	TOY40MH	TR51U		
HY20U	HU87RMH	TOY40RM	TR49U		
HY21U	HYN17MH	TOY41RMH	TR41U		
HY21SU	HYN17RMH	TOY43MH	TR47U		
ISU5U	ISU5MH	TOY43RMH	TR47SU		

## HERLEIDING HOEFIJZERSLEUTELS

SILCA	KEYLINE	SILCA	KEYLINE	SILCA	KEYLINE
B111-PT	B106U	HU92RMH	BM2U	TOY49MH	KI22U
BW9MH	BM9U	HYN10MH	HY10U	TOY49MH	TR48U
DAT17MH	SUB1U	HYN12MH	HY12U	TOY49MH	TR53U
DH4RMH	DAI1SU	HYN14MH	HY14U	VA2MH	PG33U
DW05RMH	DAE47SU	HYN14RH	HY14SU	VAC102MI	VE20U
DWO4MH	DAE48U	HYN17MH	HY21U	VAG	HU163SU
DWO4RMH	DAE48SU	HYN17RMH	HY21SU	VX	VX6U
DWO5MH	DAE47U	HYN6MH	HY6U	YM27MH	VX3U
DWO5MH	OPL1U	HYN7RMH	HY7SU	YM28MH	VX2U
DWO6MH	DAE49U	ISU5MH	ISU5U		
F026MH	FD20U	KIA3RMH	KI3SU		
GT10MH	FT50U	MIT	MT1U		
FO38RMH	FD21U	MAZ24RMH	MZ24U		
GT16MH	AR16U	MIT8RMH	MT8SU		
HON58RMH	HD72U	NE38MH	RV4U		
HON58RMH	HD90U	NE73MH	RN30U		
HON63MH	HD71U	NE78MH	PG31U		
HON66MH	HD1U	NSN11MH	NS27U		
HON70MH	HD70U	NSN14MH	NS34U		
HU100MH	VX5U	NSN19MH	SUB2U		
HU101MH	FD40U		AR20U		
HU133RMH	SU19U	SIP22MH	FT22U		
HU134MH	SU20U	SSY3MH	SY2SU		
HU136MH	VE25U	SU11MH	SU17SU		
HU162MH	HU162U	SU11RMH	SU17U		
HU43MH	VX4U	SX9MH	CN22U		
HU46MH	VX1U	SZ12RMH	SU15U		
HU49MH	V35U	SZ13RMH	SU13SU		
HU49RMH	V35SU	SZ17RMH	SU14SU		
HU56RMH	MT15U	SZ17RMH	SU21U		
HU64MH	MB57U	TOY40MH	TR51U		
HU66MH	V66U	TOY40RM	TR49U		
HU71MH	HU71U	TOY41RMH	TR41U		
HU83MH	PG83U	TOY43MH	TR47U		
HU87RMH	HY20U	TOY43RMH	TR47SU		
HU87RMH	SU18U	TOY47MH	TR56U		

## HERLEIDING POD SLEUTELS

KEYLINE	SILCA	KEYLINE	SILCA
AD35TK	HU49BTE	RN30TK	NE73TE
AD66TK	HU66BTE	RV3TK	NE77RTE
AR16TK	GT16TE	SU15TK	SUZ12TE
B106U	SIP16TE	SU17STK	SZ11TE
BM2TK	HU92RTE	SU17TK	SZ11RTE
BM9TK	BW9TE	SU19TK	HU133TE
CN22TK	SC9TE	SUB1TE	DAT17TE
DAE47STK	DWO5RTE	SUB2TK	NSN19TE
DAE47TK	DWO5TE	SY3STK	SSY3TE
DAE48TK	DWO4TE	TR41TK	TOY41RATE
DWO48STK	DWO4RTE	TR47TK	TOY43RTE
FD20TK	FO26TE	TR48TK	TOY48TE
FD21TK	F038RTE	TR49TK	TOY40BTE
FD3TK	FO21TE	TR51TK	TOY40TE
FD40TK	HU101TE	TR56TK	TOY47TE
FT22TK	SIP22TE	V35ST	HU49TE
FT50TK	GT10BTE	V35TK	HU49TE
HD70TK	HON70TE	V66TK	HU66TE
HD90TK	HON58RTE	V70TK	HU70TE
HY10TK	HYN10TE	VE20TK	VAC102TE
HY12TK	HYN12TE	VL10TK	NE51TK
HY14STK	HYN14RTE	VL15TK	HU56RTE
HY14TK	HYN14TE	VL17TK	NE66TE
HY6TK	HYN6TE	VX1TK	HU46TE
HY7STK	HYN7RTE	VX2TK	YM28TE
ISU5TK	ISU5TE	VX3TK	YM27TE
JA2T	TBE1TE	VX4TK	HU43TE
KI3STK	KIA3RTE	VX5BTK	HU100TE
MT11BTK	MIT11RTE	Y159TK	CY24TE
MT1BTK		Y170TK	Y-160-PT
MT8SBK	MIT8RTE	YS15T	YM15TE
MY15TK	HU56RTE		
MZ24TK	MAZ24RTE		
NS27TK	NSN11TE		
PG31TK	NE78TE		
PG33TK	VA2TE		
PG83TK	HU83TE		
R47STK	TOY43TE		

## HERLEIDING POD SLEUTELS

SILCA	KEYLINE	SILCA	KEYLINE	SILCA	KEYLINE
<b>BW9TE</b>	BM9TK	<b>KIA3RTE</b>	KI3STK		
<b>CY24TE</b>	Y159TK	<b>MAZ24RTE</b>	MZ24TK		
<b>DAT17TE</b>	SUB1TE	<b>MIT11RTE</b>	MT11BTK		
<b>DWO4RTE</b>	DWO48STK	<b>MIT8RTE</b>	MT8SBK		
<b>DWO4TE</b>	DAE48TK	<b>NE51</b>	VL10TK		
<b>DWO5RTE</b>	DAE47STK	<b>NE66TE</b>	VL17TK		
<b>DWO5TE</b>	DAE47TK	<b>NE73TE</b>	RN30TK		
<b>F038RTE</b>	FD21TK	<b>NE77RTE</b>	RV3TK		
<b>FO21TE</b>	FD3TK	<b>NE78TE</b>	PG31TK		
<b>FO26TE</b>	FD20TK	<b>NSN11TE</b>	NS27TK		
<b>GT10BTE</b>	FT50TK	<b>NSN19TE</b>	SUB2TK		
<b>HON70TE</b>	HD70TK	<b>SIP22TE</b>	FT22TK		
<b>HON58RTE</b>	HD90TK	<b>SIP16TE</b>	B106U		
<b>HU101TE</b>	FD40TK	<b>SUZ12TE</b>	SU15TK		
<b>HU133TE</b>	SU19TK	<b>SZ11RTE</b>	SU17TK		
<b>HU43TE</b>	VX4TK	<b>SZ11TE</b>	SU17STK		
<b>HU46TE</b>	VX1TK	<b>TBE1TE</b>	JA2T		
<b>HU49BTE</b>	AD35TK	<b>TOY40BTE</b>	TR49TK		
<b>HU49TE</b>	V35ST	<b>TOY40TE</b>	TR51TK		
<b>HU49TE</b>	V35TK	<b>TOY41RATE</b>	TR41TK		
<b>HU56RTE</b>	MY15TK		TR47TK		
<b>HU56RTE</b>	VL15TK	<b>TOY43TE</b>	R47STK		
<b>HU66BTE</b>	AD66TK	<b>TOY47TE</b>	TR56TK		
<b>HU66TE</b>	V66TK	<b>TOY48TE</b>	TR48TK		
<b>HU70TE</b>	V70TK	<b>VA2TE</b>	PG33TK		
<b>HU83TE</b>	PG83TK	<b>VAC102TE</b>	VE20TK		
<b>HU92RTE</b>	BM2TK				
<b>HYN10TE</b>	HY10TK	<b>Y-160-PT</b>	Y170TK		
<b>HYN12TE</b>	HY12TK	<b>YM15TE</b>	YS15T		
<b>HYN14RTE</b>	HY14STK	<b>YM27TE</b>	VX3TK		
<b>HYN14TE</b>	HY14TK	<b>YM28TE</b>	VX2TK		
<b>HYN6TE</b>	HY6TK		MT1BTK		
<b>HYN7RTE</b>	HY7STK				
<b>ISU5TE</b>	ISU5TK				







# FANCY SLEUTELS

## FANCY SLEUTELS

### GEKLEURDE COR6D



COR6D-320



COR6D-HEART

### GEKLEURDE UN5D



UN5D-8U



UN5D-8V



UN5D-8X



UN5D-8W

### GEKLEURDE UN5D



UN5D-8Y



UN5D-407



UN5D-DOLPHIN



UN5D-PUPPY

## FANCY SLEUTELS

### GEKLEURDE UN5D



UN5D-KITTY



UN5D-101



UN5D-414



UND5-102

### GEKLEURDE UN5D



UN5D-410



UN5D-413



UN5D-214



UN5D-253

### GEKLEURDE UN5D



UND5D-408



UN5D-406



UN5D-102



UN5D-415

## FANCY SLEUTELS

### GEKLEURDE UN5D



UN5D-310



UN5D-375



UN5D-412



UN5D-320

### GEKLEURDE UN5D



UB5D-105



UN5D-327



# LEGE AUTO BEHUIZINGEN

## AUTOSLEUTEL BEHUIZINGEN

AFBEELDING:	ART. NR.:	OMSCHRIJVING:
-------------	-----------	---------------

### BMW



**BMW-S11**

BMW BEHUIZING,  
3 KNOPPEN,  
PROFIEL BM22, HU92R  
ZONDER BATTERIJHOUDER



**BMW-S21A**

BMW BEHUIZING,  
3 KNOPPEN,  
PROFIEL BM22, HU92R  
ZONDER BATTERIJHOUDER

### FIAT



**FIA-S04A**

FIAT BEHUIZING,  
1 KNOP,  
PROFIEL FT22, SIP22  
ZONDER BATTERIJHOUDER



**FIA-S04B**

FIAT BEHUIZING,  
1 KNOP,  
PROFIEL FT1505, GT15R  
ZONDER BATTERIJHOUDER

## AUTOSLEUTEL BEHUIZINGEN

AFBEELDING:	ART. NR.:	OMSCHRIJVING:
-------------	-----------	---------------

### FIAT



**FIA-S13B1**

FIAT BEHUIZING,  
 2 KNOPPEN,  
 PROFIEL FT22, SIP22  
 MET BATTERIJHOUDER



**FIA-S14B1**

FIAT BEHUIZING,  
 3 KNOPPEN,  
 PROFIEL FT22, SIP22  
 MET BATTERIJHOUDER



**FIA-S15A**

FIAT BEHUIZING,  
 3 KNOPPEN,  
 PROFIEL FT22, SIP22  
 MET BATTERIJHOUDER



**FIA-S30C**

FIAT BEHUIZING,  
 2 KNOPPEN,  
 PROFIEL FT1505, GT15R  
 MET BATTERIJHOUDER

## AUTOSLEUTEL BEHUIZINGEN

AFBEELDING:	ART. NR.:	OMSCHRIJVING:
-------------	-----------	---------------

### FORD



**FOR-S14A**

FORD BEHUIZING,  
3 KNOPPEN,  
PROFIEL FT22 (SIP22)  
ZONDER BATTERIJHOUDER



**FOR-S14B**

FORD BEHUIZING,  
3 KNOPPEN  
MET BATTERIJHOUDER



**FOR-S16**

FORD ONDERSTUK,  
PROFIEL FD40, HU101



**FOR-S20**

FORD BEHUIZING,  
3 KNOPPEN  
ZONDER BATTERIJHOUDER



## AUTOSLEUTEL BEHUIZINGEN

AFBEELDING:	ART. NR.:	OMSCHRIJVING:
<b>FORD</b>		



**FOR-S32A**

FORD BEHUIZING,  
 3 KNOPPEN  
 ZONDER BATTERIJHOUDER



**FOR-S61A**

FORD BEHUIZING,  
 3 KNOPPEN,  
 PROFIEL FD40, HU101  
 ZONDER BATTERIJHOUDER



**FOR-S61B**

FORD BEHUIZING,  
 3 KNOPPEN,  
 PROFIEL FD3, FO21  
 ZONDER BATTERIJHOUDER



**FOR-S72**

FORD SLEUTELBEHUIZING ,  
 3 KNOPPEN,  
 PROFIEL FT22 (SIP22)  
 MET BATTERIJHOUDER

**AUTOSLEUTEL BEHUIZINGEN**

AFBEELDING:	ART. NR.:	OMSCHRIJVING:
<b>FORD</b>		



**FOR-S11**

ONDERSTUK FORD,  
PROFIEL FD40 (HU101)



**FOR-S13**

ONDERSTUK FORD,  
PROFIEL FD3 (FO21)

## AUTOSLEUTEL BEHUIZINGEN

AFBEELDING:	ART. NR.:	OMSCHRIJVING:
-------------	-----------	---------------

### HYUNDAI



**HYU-S15B**

HYUNDAI BEHUIZING,  
 2 KNOPPEN  
 ZONDER BATTERIJHOUDER



**HYU-S15C**

HYUNDAI BEHUIZING,  
 3 KNOPPEN  
 ZONDER BATTERIJHOUDER



**HYU-S26C**

HYUNDAI BEHUIZING,  
 3 KNOPPEN,  
 PROFIEL HY14, HYN14  
 ZONDER BATTERIJHOUDER



**HYU-S26D**

HYUNDAI BEHUIZING,  
 3 KNOPPEN,  
 PROFIEL HY14S, HYN14R  
 ZONDER BATTERIJHOUDER

## AUTOSLEUTEL BEHUIZINGEN

AFBEELDING:	ART. NR.:	OMSCHRIJVING:
-------------	-----------	---------------

### HYUNDAI



**HYU-S26E**

HYUNDAI BEHUIZING,  
3 KNOPPEN,  
PROFIEL TOY49  
ZONDER BATTERIJHOUDER



**HYU-S44B**

HYUNDAI BEHUIZING,  
1 KNOP,  
PROFIEL HYN11



**HYU-S53A**

HYUNDAI BEHUIZING,  
3 KNOPPEN,  
PROFIEL TOY49  
ZONDER BATTERIJHOUDER

### KIA



**KIA-S17B**

KIA BEHUIZING,  
3 KNOPPEN,  
PROFIEL TOY49  
ZONDER BATTERIJHOUDER

## AUTOSLEUTEL BEHUIZINGEN

AFBEELDING:	ART. NR.:	OMSCHRIJVING:
-------------	-----------	---------------

### MAZDA



MAZ-S09D  
 MAZDA BEHUIZING,  
 2 KNOPPEN  
 MET BATTERIJHOUDER



MAZ-S27B  
 MAZDA BEHUIZING,  
 2 KNOPPEN  
 MET BATTERIJHOUDER



MAZ-S28A  
 MAZDA BEHUIZING,  
 3 KNOPPEN,  
 PROFIEL MZ24, MAZ24R  
 MET BATTERIJHOUDER



MAZ-S29  
 MAZDA ONDERSTUK,  
 PROFIEL MZ24, MAZ24R

## AUTOSLEUTEL BEHUIZINGEN

AFBEELDING:

ART. NR.:

OMSCHRIJVING:

### MERCEDES



**MER-S05E**

MERCEDES LEGE  
TRANSPONDERSLEUTEL,  
PROFIEL YS15, YM15

### MINI



**BMW-S09**

MINI BEHUIZING  
2 KNOPPEN,  
PROFIEL BM22, HU92R  
ZONDER BATTERIJHOUDER



**BMW-S27**

MINI BEHUIZING  
3 KNOPPEN,  
PROFIEL BM22, HU92R  
ZONDER BATTERIJHOUDER

## AUTOSLEUTEL BEHUIZINGEN

AFBEELDING:	ART. NR.:	OMSCHRIJVING:
-------------	-----------	---------------

### MITSUBISHI



**MIT-S09B**

MITSUBISHI BEHUIZING,  
 2 KNOPPEN,  
 PROFIEL VL15R, HU56R  
 ZONDER BATTERIJHOUDER



**MIT-S24A**

MITSUBISHI BEHUIZING,  
 2 KNOPPEN,  
 PROFIEL MT8, MIT11



**MIT-S24B**

MITSUBISHI BEHUIZING,  
 2 KNOPPEN,  
 PROFIEL MT8S, MIT11R

## AUTOSLEUTEL BEHUIZINGEN

AFBEELDING:	ART. NR.:	OMSCHRIJVING:
<b>OPEL</b>		



**OPE-S04**

OPEL BEHUIZING,  
2 KNOPPEN  
MET BATTERIJHOUDER



**OPE-S05**

OPEL BEHUIZING,  
2 KNOPPEN  
ZONDER BATTERIJHOUDER



**OPE-S06**

OPEL BEHUIZING,  
3 KNOPPEN  
ZONDER BATTERIJHOUDER



**OPE-S16**

OPEL ONDERSTUK,  
PROFIEL VX1, HU46



## AUTOSLEUTEL BEHUIZINGEN

AFBEELDING:	ART. NR.:	OMSCHRIJVING:
-------------	-----------	---------------

### OPEL



**OPE-S17**

OPEL ONDERSTUK,  
 PROFIEL VX2, YM28



**OPE-S18**

OPEL ONDERSTUK,  
 PROFIEL VX5, HU100



**OPE-S18B**

OPEL ONDERSTUK,  
 PROFIEL VX4, HU43



**OPE-S19**

OPEL ONDERSTUK,  
 PROFIEL VX1, HU46

## AUTOSLEUTEL BEHUIZINGEN

AFBEELDING:	ART. NR.:	OMSCHRIJVING:
-------------	-----------	---------------

### OPEL



**OPE-S20**

OPEL ONDERSTUK,  
PROFIEL VX2, YM28



**OPE-S21**

OPEL ONDERSTUK,  
PROFIEL VX4, HU43



**OPE-S21B**

OPEL ONDERSTUK,  
PROFIEL VX5, HU100



**OPE-S22**

OPEL BEHUIZING,  
2 KNOPPEN,  
PROFIEL VX5, HU100  
MET BATTERIJHOUDER

## AUTOSLEUTEL BEHUIZINGEN

AFBEELDING:	ART. NR.:	OMSCHRIJVING:
-------------	-----------	---------------

### OPEL



**OPE-S23**

OPEL BEHUIZING,  
 3 KNOPPEN,  
 PROFIEL VX5, HU100  
 MET BATTERIJHOUDER



**OPE-S39**

OPEL BEHUIZING,  
 2 KNOPPEN,  
 PROFIEL VX5, HU100  
 MET BATTERIJHOUDER



**OPE-S40**

OPEL BEHUIZING,  
 3 KNOPPEN,  
 PROFIEL VX5, HU100  
 MET BATTERIJHOUDER



**OPE-S46B**

OPEL BEHUIZING,  
 2 KNOPPEN,  
 PROFIEL VX5, HU100  
 ZONDER BATTERIJHOUDER

## AUTOSLEUTEL BEHUIZINGEN

AFBEELDING:

ART. NR.:

OMSCHRIJVING:

### OPEL



**OPE-S47B**

OPEL BEHUIZING,  
3 KNOPPEN,  
PROFIEL VX5, HU100  
ZONDER BATTERIJHOUDER



**OPE-S38A** SLEUTELBAARD VX4 - HU43

## AUTOSLEUTEL BEHUIZINGEN

AFBEELDING:	ART. NR.:	OMSCHRIJVING:
-------------	-----------	---------------

### PSA (CITROËN / PEUGEOT)



**CIT-S26**

CITROËN BEHUIZING,  
 2 KNOPPEN  
 ZONDER BATTERIJHOUDER



**CIT-S22**

CITROËN BEHUIZING,  
 2 KNOPPEN,  
 PROFIEL CN22, SX9  
 ZONDER BATTERIJHOUDER



**PSA-S01A**

PEUGEOT / CITROËN  
 BEHUIZING,  
 2 KNOPPEN,  
 PROFIEL PG33, VA2  
 MET BATTERIJHOUDER



**PSA-S01B**

PEUGEOT / CITROËN  
 BEHUIZING,  
 2 KNOPPEN,  
 PROFIEL PG33, VA2  
 ZONDER BATTERIJHOUDER

## AUTOSLEUTEL BEHUIZINGEN

AFBEELDING:

ART. NR.:

OMSCHRIJVING:

### PSA (CITROEN / PEUGEOT)



**PSA-S02A**

PEUGEOT / CITROËN  
BEHUIZING,  
2 KNOPPEN,  
PROFIEL PG83, VA2  
MET BATTERIJHOUDER



**PSA-S02B**

PEUGEOT / CITROËN  
BEHUIZING,  
2 KNOPPEN,  
PROFIEL PG83, VA2  
ZONDER BATTERIJHOUDER



**PSA-S04A**

PEUGEOT / CITROËN  
BEHUIZING,  
2 KNOPPEN,  
PROFIEL PG31, NE78  
MET BATTERIJHOUDER



**PSA-S04B**

PEUGEOT / CITROËN  
BEHUIZING,  
2 KNOPPEN,  
PROFIEL PG31, NE78  
ZONDER BATTERIJHOUDER

## AUTOSLEUTEL BEHUIZINGEN

AFBEELDING:

ART. NR.:

OMSCHRIJVING:

### PSA (CITROËN / PEUGEOT)



**PSA-S05A**

PEUGEOT / CITROËN  
 BEHUIZING,  
 3 KNOPPEN,  
 PROFIEL PG33, VA2  
 MET BATTERIJHOUDER



**PSA-S05B**

PEUGEOT / CITROËN  
 BEHUIZING,  
 3 KNOPPEN,  
 PROFIEL PG33, VA2  
 ZONDER BATTERIJHOUDER



**PSA-S07A**

PEUGEOT / CITROËN  
 BEHUIZING,  
 3 KNOPPEN,  
 PROFIEL PG31, NE78  
 MET BATTERIJHOUDER



**PSA-S07B**

PEUGEOT / CITROËN  
 BEHUIZING,  
 3 KNOPPEN,  
 PROFIEL PG31, NE78  
 ZONDER BATTERIJHOUDER

## AUTOSLEUTEL BEHUIZINGEN

AFBEELDING:

ART. NR.:

OMSCHRIJVING:

### PSA (CITROËN / PEUGEOT)



**PSA-S08A**

PEUGEOT / CITROËN  
BEHUIZING,  
3 KNOPPEN,  
PROFIEL PG33, VA2  
MET BATTERIJHOUDER



**PSA-S08B**

PEUGEOT / CITROËN  
BEHUIZING,  
3 KNOPPEN,  
PROFIEL PG33, VA2  
ZONDER BATTERIJHOUDER



**PSA-S09A**

PEUGEOT / CITROËN  
BEHUIZING,  
3 KNOPPEN,  
PROFIEL PG83, HU83  
MET BATTERIJHOUDER



**PSA-S09B**

PEUGEOT / CITROËN  
BEHUIZING,  
3 KNOPPEN,  
PROFIEL PG83, HU83  
ZONDER BATTERIJHOUDER



## AUTOSLEUTEL BEHUIZINGEN

AFBEELDING:	ART. NR.:	OMSCHRIJVING:
-------------	-----------	---------------

### PSA (CITROEN / PEUGEOT)



**PSA-S11A**

PEUGEOT / CITROËN  
 BEHUIZING,  
 4 KNOPPEN,  
 PROFIEL PG33, VA2  
 MET BATTERIJHOUDER



**PSA-S12A**

PEUGEOT / CITROËN  
 BEHUIZING,  
 4 KNOPPEN,  
 PROFIEL PG83, HU83  
 MET BATTERIJHOUDER



**PSA-S23B**

PEUGEOT / CITROËN  
 BEHUIZING,  
 2 KNOPPEN,  
 PROFIEL RN30, NE73  
 ZONDER BATTERIJHOUDER



**PSA-S24B**

PEUGEOT / CITROËN  
 BEHUIZING,  
 2 KNOPPEN,  
 PROFIEL PG33, VA2  
 ZONDER BATTERIJHOUDER

## AUTOSLEUTEL BEHUIZINGEN

AFBEELDING:

ART. NR.:

OMSCHRIJVING:

### PSA (CITROEN / PEUGEOT)



**PSA-S25B**

PEUGEOT / CITROËN  
BEHUIZING,  
2 KNOPPEN,  
PROFIEL PG83, HU83  
ZONDER BATTERIJHOUDER



**PSA-S26B**

PEUGEOT / CITROËN  
BEHUIZING,  
2 KNOPPEN,  
PROFIEL PG31, NE78  
ZONDER BATTERIJHOUDER



**PSA-S27B**

PEUGEOT / CITROËN  
BEHUIZING,  
2 KNOPPEN,  
PROFIEL CN22, SX9  
ZONDER BATTERIJHOUDER



**PSA-S49B**

PEUGEOT / CITROËN  
BEHUIZING,  
2 KNOPPEN,  
PROFIEL RN30, NE73  
ZONDER BATTERIJHOUDER  
MET LED

## AUTOSLEUTEL BEHUIZINGEN

AFBEELDING:

ART. NR.:

OMSCHRIJVING:

### PSA (CITROEN / PEUGEOT)



**PSA-S49C**

PEUGEOT / CITROËN  
BEHUIZING,  
2 KNOPPEN,  
PROFIEL RN30, NE73  
MET BATTERIJHOUDER



**PSA-S50B**

PEUGEOT / CITROËN  
BEHUIZING,  
2 KNOPPEN,  
PROFIEL PG31, NE78  
ZONDER BATTERIJHOUDER

## AUTOSLEUTEL BEHUIZINGEN

AFBEELDING:	ART. NR.:	OMSCHRIJVING:
<b>RENAULT</b>		



**REN-S02A**

RENAULT BEHUIZING,  
1 KNOP,  
PROFIEL RN30, NE73  
ZONDER BATTERIJHOUDER



**REN-S02B**

RENAULT BEHUIZING,  
1 KNOP,  
PROFIEL VE20, VAC102  
ZONDER BATTERIJHOUDER



**REN-S03B**

RENAULT BEHUIZING,  
1 KNOP,  
PROFIEL RN30, NE73  
ZONDER BATTERIJHOUDER



**REN-S03D**

RENAULT BEHUIZING,  
1 KNOP,  
PROFIEL VE20, VAC102  
ZONDER BATTERIJHOUDER

## AUTOSLEUTEL BEHUIZINGEN

AFBEELDING:	ART. NR.:	OMSCHRIJVING:
-------------	-----------	---------------

### RENAULT



**REN-S04A**

RENAULT BEHUIZING,  
 2 KNOPPEN,  
 PROFIEL RN30, NE73  
 ZONDER BATTERIJHOUDER



**REN-S04B**

RENAULT BEHUIZING,  
 2 KNOPPEN,  
 PROFIEL VE20, VAC102  
 ZONDER BATTERIJHOUDER



**REN-S05A**

RENAULT BEHUIZING,  
 2 KNOPPEN,  
 PROFIEL RN30, NE73  
 MET BATTERIJHOUDER



**REN-S05D**

RENAULT BEHUIZING,  
 2 KNOPPEN,  
 PROFIEL VE20, VAC102  
 MET BATTERIJHOUDER

## AUTOSLEUTEL BEHUIZINGEN

AFBEELDING:

ART. NR.:

OMSCHRIJVING:

### RENAULT



**REN-S06C**

RENAULT BEHUIZING,  
3 KNOPPEN,  
PROFIEL RN30, NE73  
MET BATTERIJHOUDER



**REN-S06D**

RENAULT BEHUIZING,  
3 KNOPPEN, PROFIEL VE20,  
VAC102  
MET BATTERIJHOUDER



**REN-S07B**

RENAULT BEHUIZING,  
2 KNOPPEN,  
PROFIEL PG33, VA2  
MET BATTERIJHOUDER



**REN-S08B**

RENAULT BEHUIZING,  
3 KNOPPEN,  
PROFIEL PG33T, VA2  
MET BATTERIJHOUDER

## AUTOSLEUTEL BEHUIZINGEN

AFBEELDING:	ART. NR.:	OMSCHRIJVING:
<b>RENAULT</b>		



**REN-S23A**

RENAULT BEHUIZING,  
 1 KNOP,  
 PROFIEL RN30, NE73  
 ZONDER BATTERIJHOUDER



**REN-S23B**

RENAULT BEHUIZING,  
 1 KNOP,  
 PROFIEL VE20, VAC102  
 ZONDER BATTERIJHOUDER



**REN-S24A**

RENAULT BEHUIZING,  
 1 KNOP,  
 PROFIEL RN30, NE73  
 ZONDER BATTERIJHOUDER



**REN-S24B**

RENAULT BEHUIZING,  
 1 KNOP,  
 PROFIEL VE20, VAC102  
 ZONDER BATTERIJHOUDER



---

**AUTOSLEUTEL BEHUIZINGEN**

---

AFBEELDING:

ART. NR.:

OMSCHRIJVING:

---

**RENAULT**

---



**REN-S28B**

BEHUIZING RENAULT, GEEN  
DRUKKNOPPEN.  
PROFIEL VE20, VAC102



**REN-S35**

SLEUTELPROFIEL  
DACIA / RENAULT  
2014+  
PROFIEL VE20, VAC102



## AUTOSLEUTEL BEHUIZINGEN

AFBEELDING:	ART. NR.:	OMSCHRIJVING:
<b>SUZUKI</b>		
	<b>SUZ-S06C</b>	SUZUKI DRUKTOETSEN 2 KNOPPEN
	<b>SUZ-S06E</b>	SUZUKI BEHUIZING, 2 KNOPPEN, PROFIEL SU18, HU87R ZONDER BATTERIJHOUDER
	<b>SUZ-S06F</b>	SUZUKI BEHUIZING, 2 KNOPPEN, PROFIEL TR47, TOY43 ZONDER BATTERIJHOUDER
	<b>SUZ-S06G</b>	SUZUKI BEHUIZING, 2 KNOPPEN, PROFIEL SU17, SZ11R ZONDER BATTERIJHOUDER
	<b>SUZ-S11</b>	SUZUKI BEHUIZING, 2 KNOPS, INCLUSIEF NOODSLEUTEL EN BATTERIJHOUDER

**AUTOSLEUTEL BEHUIZINGEN**

AFBEELDING:	ART. NR.:	OMSCHRIJVING:
<b>TOYOTA</b>		



**TOY-S39**

TOYOTA DRUKTOETSEN,  
3 KNOPPEN



**TOY-S11B**

TOYOTA BEHUIZING,  
2 KNOPPEN,  
PROFIEL TR41, TOY41R  
ZONDER BATTERIJHOUDER



**TOY-S11C**

TOYOTA BEHUIZING,  
3 KNOPPEN,  
PROFIEL TR41, TOY41R  
ZONDER BATTERIJHOUDER

## AUTOSLEUTEL BEHUIZINGEN

AFBEELDING:	ART. NR.:	OMSCHRIJVING:
<b>TOYOTA</b>		



**TOY-S18**

TOYOTA BEHUIZING,  
 2 KNOPPEN,  
 PROFIEL TR49, TOY40  
 ZONDER BATTERIJHOUDER



**TOY-S19**

TOYOTA BEHUIZING,  
 3 KNOPPEN,  
 PROFIEL TR49, TOY40  
 ZONDER BATTERIJHOUDER



**TOY-S20**

TOYOTA BEHUIZING,  
 2 KNOPPEN,  
 PROFIEL TR47, TOY43  
 ZONDER BATTERIJHOUDER



**TOY-S21**

TOYOTA BEHUIZING,  
 3 KNOPPEN,  
 PROFIEL TR47, TOY43  
 ZONDER BATTERIJHOUDER

**AUTOSLEUTEL BEHUIZINGEN**

AFBEELDING:	ART. NR.:	OMSCHRIJVING:
-------------	-----------	---------------

**TOYOTA**



**TOY-S22**

TOYOTA BEHUIZING,  
2 KNOPPEN,  
PROFIEL TR56, TOY47  
ZONDER BATTERIJHOUDER



**TOY-S23**

TOYOTA BEHUIZING,  
3 KNOPPEN,  
PROFIEL TR56, TOY47  
ZONDER BATTERIJHOUDER



**TOY-S24**

TOYOTA BEHUIZING,  
2 KNOPPEN,  
PROFIEL TR48, TOY48  
ZONDER BATTERIJHOUDER



**TOY-S25**

TOYOTA BEHUIZING,  
3 KNOPPEN,  
PROFIEL TR48, TOY48  
ZONDER BATTERIJHOUDER

## AUTOSLEUTEL BEHUIZINGEN

AFBEELDING:

ART. NR.:

OMSCHRIJVING:

### VAG (AUDI, SEAT, SKODA, VW)



**VAG-S02B**

VAG, LEGE  
 TRANSPONDERSLEUTEL,  
 PROFIEL V66, HU66



**AU-S18**

VAG BEHUIZING,  
 2 KNOPPEN  
 MET BATTERIJHOUDER



**AU-S20**

VAG BEHUIZING,  
 3 KNOPPEN  
 MET BATTERIJHOUDER



**VAG-S11**

VAG ONDERSTUK,  
 PROFIEL V66, HU66

## AUTOSLEUTEL BEHUIZINGEN

AFBEELDING:

ART. NR.:

OMSCHRIJVING:

### VAG (AUDI, SEAT, SKODA, VW)



**VAG-S14**

VAG ONDERSTUK,  
PROFIEL V35, HU49



**VAG-S18**

VAG ONDERSTUK,  
PROFIEL V66, HU66



**VAG-S21**

VAG BEHUIZING,  
2 KNOPPEN  
MET BATTERIJHOUDER



**VAG-S22**

VAG BEHUIZING,  
3 KNOPPEN  
MET BATTERIJHOUDER

## AUTOSLEUTEL BEHUIZINGEN

AFBEELDING:

ART. NR.:

OMSCHRIJVING:

### VAG (AUDI, SEAT, SKODA, VW)



**VAG-S33**

VAG ONDERSTUK,  
 PROFIEL V66, HU66



**VAG-S48**

VAG BEHUIZING,  
 3 KNOPPEN,  
 PROFIEL V66, HU66  
 ZONDER BATTERIJHOUDER



**VAG-S52**

VAG BEHUIZING,  
 3 KNOPPEN,  
 PROFIEL V66, HU66  
 MODEL MET BORGSTIFT,  
 NA 2011  
 ZONDER BATTERIJHOUDER



**VAG-S53A**

VAG BEHUIZING,  
 2 KNOPPEN,  
 PROFIEL V66, HU66  
 MODEL MET BORGSTIFT,  
 NA 2011  
 ZONDER BATTERIJHOUDER

## AUTOSLEUTEL BEHUIZINGEN

AFBEELDING:

ART. NR.:

OMSCHRIJVING:

### VAG (AUDI, SEAT, SKODA, VW)



**VAG-S59C**

VAG BEHUIZING,  
4 KNOPPEN,  
PROFIEL V66, HU66  
ZONDER BATTERIJHOUDER



**VAG-S62A**

VAG BEHUIZING,  
3 KNOPPEN,  
PROFIEL V66, HU66  
ZONDER BATTERIJHOUDER



**VAG-S62B**

VAG BEHUIZING,  
3 KNOPPEN,  
PROFIEL V66, HU66  
MET BATTERIJHOUDER



**VAG-S62C**

VAG BEHUIZING,  
3 KNOPPEN,  
PROFIEL V66, HU66  
ZONDER BATTERIJHOUDER



## AUTOSLEUTEL BEHUIZINGEN

AFBEELDING:

ART. NR.:

OMSCHRIJVING:

### VAG (AUDI, SEAT, SKODA, VW)



**VAG-S62D**

VAG BEHUIZING,  
 3 KNOPPEN,  
 PROFIEL V66, HU66  
 ZONDER BATTERIJHOUDER



**VAG-S62F**

VAG BEHUIZING,  
 3 KNOPPEN,  
 PROFIEL V66, HU67  
 ZONDER BATTERIJHOUDER

### VOLVO



**VOL-S04D**

VOLVO BEHUIZING,  
 4 KNOPPEN  
 MET BATTERIJHOUDER



**VOL-S06D**

VOLVO BEHUIZING,  
 5 KNOPPEN  
 MET BATTERIJHOUDER





# AUTOSLEUTELS EN AFSTANDBEDIENINGEN

## AUTOSLEUTELS EN AFSTANDSBEDIENINGEN

AFBEELDING:	ART. NR.:	OMSCHRIJVING:
-------------	-----------	---------------

### AUDI

#### AUDI KEYLESS



AUD-  
R001

#### EIGENSCHAPPEN:

TRANSPONDER:	ID48 MEGAMOS 88
KEYLESS:	JA
FREQUENTIE	434 MHZ ASK
BATTERIJ:	CR2032
ORIGINELE NUMMER:	8S0.959.754
NOODSLEUTEL:	NEE
PROFIEL:	FT22 - SIP22
MODEL:	3 KNOPPEN
MODELLEN:	A3 (2015+) Q7 (2014+)
	TT (2015+) S TT (2015+)

#### AUDI A3/S3/RS3



AUD-  
R002

#### EIGENSCHAPPEN:

TRANSPONDER:	ID48 AUDI CAN
KEYLESS:	NEE
FREQUENTIE	434 MHZ
BATTERIJ:	CR2032
ORIGINELE NUMMER:	8V0837220/8V0837220D
NOODSLEUTEL:	NEE
PROFIEL:	V66 - HU66
MODEL:	3 KNOPPEN
MODELLEN:	A3 (2012+) S3 (2012+)
	RS3 (2012+)

#### AUDI A6/Q7



AUD-  
R003

#### EIGENSCHAPPEN:

TRANSPONDER:	8E
KEYLESS:	NEE
FREQUENTIE	
BATTERIJ:	CR2032
ORIGINELE NUMMER:	
NOODSLEUTEL:	NEE
PROFIEL:	V66 - HU66
MODEL:	3 KNOPPEN
MODELLEN:	A6 (2004-2011)
	Q7 (2007-2010)

## AUTOSLEUTELS EN AFSTANDBEDIENINGEN

AFBEELDING:	ART. NR.:	OMSCHRIJVING:
-------------	-----------	---------------

### AUDI

#### AUDI A3 / A4



AUD-R004

#### EIGENSCHAPPEN:

TRANSPONDER:	8E
KEYLESS:	NEE
FREQUENTIE	434 MHZ FSK
BATTERIJ:	CR2032
ORIGINELE NUMMER:	
NOODSLEUTEL:	NEE
PROFIEL:	V66 - HU66
MODEL:	3 KNOPPEN
MODELLEN:	A3 (2010+)
	A4 (2010+)

#### AUDI A3 / A4 / A6 / A8



AUD-R005

#### EIGENSCHAPPEN:

FREQUENTIE	434 MHZ
KEYLESS:	NEE
ORIGINELE NUMMER:	8PO837220D
NOODSLEUTEL:	NEE
PROFIEL:	V66 - HU66
MODEL:	3 KNOPPEN
MODELLEN:	A3 (2010+) A6 (2010+)

#### EIGENSCHAPPEN:

TRANSPONDER:	NEE
KEYLESS:	NEE
FREQUENTIE	433 MHZ
BATTERIJ:	CR2032
ORIGINELE NUMMER:	4DO837231R
NOODSLEUTEL:	NEE
PROFIEL:	
MODEL:	2 KNOPPEN
MODELLEN:	A3 (1999-2003)
	A4 (1997-2001)
	A6 (2001-2003)
	A8 (2002+)
	TT (1998-2002)



AUD-R006

## AUTOSLEUTELS EN AFSTANDBEDIENINGEN

AFBEELDING:	ART. NR.:	OMSCHRIJVING:
-------------	-----------	---------------

### AUDI

#### AUDI



AUD-  
R007

#### EIGENSCHAPPEN:

<b>TRANSPONDER:</b>	NEE
<b>KEYLESS:</b>	NEE
<b>FREQUENTIE</b>	434 MHZ
<b>BATTERIJ:</b>	CR2032-CR2025-CR1620
<b>ORIGINELE NUMMER:</b>	4DO837231A
	4DO837231R
	4DO837231N
<b>NOODSLEUTEL:</b>	NEE
<b>MODEL:</b>	3 KNOPPEN
<b>MODELLEN:</b>	A3 (1999-2003)
A6 (2001-2003)	A4 (1997-2001)
TT (1998-2002)	A8 (2002+)

#### AUDI A3



AUD-  
R009

#### EIGENSCHAPPEN:

<b>TRANSPONDER:</b>	NEE
<b>KEYLESS:</b>	NEE
<b>FREQUENTIE</b>	434 MHZ
<b>BATTERIJ:</b>	CR2032-CR2025-CR1620
<b>ORIGINELE NUMMER:</b>	4DO837231N
<b>NOODSLEUTEL:</b>	NEE
<b>PROFIEL:</b>	
<b>MODEL:</b>	3 KNOPPEN
<b>MODELLEN:</b>	A3 (1999-2005)
A4 (1999-2001)	A8 (1998-2002)
A6 (1997-2002)	TT (1998-2002)

## AUTOSLEUTELS EN AFSTANDSBEDIENINGEN

AFBEELDING:	ART. NR.:	OMSCHRIJVING:
-------------	-----------	---------------

### AUDI

#### AUDI A2



AUD-R010

#### EIGENSCHAPPEN:

TRANSPONDER:	NEE
KEYLESS:	NEE
FREQUENTIE	434 MHZ
BATTERIJ:	CR2032-CR2025-CR1620
ORIGINELE NUMMER:	4DO837231R
NOODSLEUTEL:	
PROFIEL:	
MODEL:	2 KNOPPEN
MODELLEN:	A3 (1999-2006) A4 (-2006)

#### AUDI A3 / A4



AUD-R011

#### EIGENSCHAPPEN:

TRANSPONDER:	NEE
KEYLESS:	NEE
FREQUENTIE	434 MHZ
BATTERIJ:	CR2032-CR2025-CR1620
ORIGINELE NUMMER:	4DO837231A
NOODSLEUTEL:	
PROFIEL:	
MODEL:	3 KNOPPEN
MODELLEN:	A3 (1999-2006) A4 (-2006)

#### AUDI



AUD-R012

#### EIGENSCHAPPEN:

TRANSPONDER:	AUDI-5 CRYPTO PCF7945AC
KEYLESS:	NEE
FREQUENTIE	868 MHZ
BATTERIJ:	CR2032
ORIGINELE NUMMER:	8K0959754H
NOODSLEUTEL:	JA
MODEL:	3 KNOPPEN
MODELLEN:	A6-A8-Q3-Q5-Q7

## AUTOSLEUTELS EN AFSTANDSBEDIENINGEN

AFBEELDING:	ART. NR.:	OMSCHRIJVING:
-------------	-----------	---------------

### AUDI

AUDI



AUD-  
R013

#### EIGENSCHAPPEN:

<b>TRANSPONDER:</b>	AUDI-5 CRYPTO PCF7945AC
<b>KEYLESS:</b>	NEE
<b>FREQUENTIE</b>	434 MHZ
<b>BATTERIJ:</b>	CR2032
<b>ORIGINELE NUMMER:</b>	8TO959754C
	8TO959754G
	8KO959754C
	8KO959754G
	8KO959754J
<b>NOODSLEUTEL:</b>	JA
<b>MODEL:</b>	3 KNOPPEN
<b>MODELLEN:</b>	A3 (2009-2012)
	A4 (2009-2012)
	A5 (2009-2012)
	S4 (2009-2012)
	S5 (2009-2012)
	S6 (2009-2012)
	Q5 (2009-2012)
	A7 (2011)

AUDI



AUD-R014

#### EIGENSCHAPPEN:

<b>TRANSPONDER:</b>	ID46 CRYPTO PCF7945AC
<b>KEYLESS:</b>	JA
<b>FREQUENTIE</b>	434 MHZ
<b>BATTERIJ:</b>	CR2032
<b>ORIGINELE NUMMER:</b>	
<b>NOODSLEUTEL:</b>	JA
<b>MODEL:</b>	3 KNOPPEN
<b>MODELLEN:</b>	A6-A8-Q3-Q5-Q7



## AUTOSLEUTELS EN AFSTANDSBEDIENINGEN

AFBEELDING:	ART. NR.:	OMSCHRIJVING:
-------------	-----------	---------------

### ALFA ROMEO

#### ALFA ROMEO GIULIETTA



ALF-R001

#### EIGENSCHAPPEN:

TRANSPONDER:	MARELLI PCF7946
KEYLESS:	NEE
FREQUENTIE	433 MHZ
BATTERIJ:	CR2032
ORIGINELE NUMMER:	
NOODSLEUTEL:	NEE
PROFIEL:	FT22 - SIP22
MODEL:	3 KNOPPEN
MODELLEN:	GIULIETTA (2008+)
MAGNETI MARELLI BODY CONTROL MODULE BSI	

#### ALFA ROMEO mito



ALF-R002

#### EIGENSCHAPPEN:

TRANSPONDER:	DELPHI PCF7946
KEYLESS:	NEE
FREQUENTIE	433 MHZ
BATTERIJ:	CR2032
ORIGINELE NUMMER:	
NOODSLEUTEL:	NEE
PROFIEL:	FT22 - SIP22
MODEL:	3 KNOPPEN
MODELLEN:	MITO (2008+)
DELPHI BODY CONTROL MODULE BSI	

#### ALFA ROMEO GUILIA KEYLESS



ALF-R003

#### EIGENSCHAPPEN:

TRANSPONDER:	CONTINENTAL / A2C97634900
KEYLESS:	JA
FREQUENTIE	434 MHZ
BATTERIJ:	CR2032
ORIGINELE NUMMER:	CR2016DJ1270
NOODSLEUTEL:	JA
PROFIEL:	FT22 - SIP22
MODEL:	3 KNOPPEN
MODELLEN:	GUILIA (CR2016+)

## AUTOSLEUTELS EN AFSTANDSBEDIENINGEN

AFBEELDING:	ART. NR.:	OMSCHRIJVING:
-------------	-----------	---------------

### BMW

#### BMW 7 SERIE



BMW

BMW-  
R001

#### EIGENSCHAPPEN:

TRANSPONDER:	ID46-PCF7942
KEYLESS:	JA
FREQUENTIE	868 MHZ
BATTERIJ:	CR2450
ORIGINELE NUMMER:	
NOODSLEUTEL:	JA
PROFIEL:	BM2 - HU92
MODEL:	3 KNOPPEN
MODELLEN:	7 SERIE (-2011) E65 SERIES

#### EIGENSCHAPPEN:

TRANSPONDER:	ID46-PCF7945
KEYLESS:	JA
FREQUENTIE	868 MHZ
BATTERIJ:	CR2020/CR2025 SOLDEREN
ORIGINELE NUMMER:	
NOODSLEUTEL:	JA
PROFIEL:	BM2 - HU92
MODEL:	2 KNOPPEN
MODELLEN:	Z E89 (2012)
	1 SERIE E81/E87/E88 (2005-2011)
	3 SERIE E90/E91/E92/E93 (2006-2011)
	5 SERIE E60/E61 (2005-2010)
	X5 E70 (10.2006-2008)

#### BMW F



BMW-  
R003

#### EIGENSCHAPPEN:

TRANSPONDER:	PCF7953 (HITAG PRO)
KEYLESS:	JA
FREQUENTIE	434 MHZ
BATTERIJ:	CRCR2025 SOLDEREN OF CR2032
ORIGINELE NUMMER:	
NOODSLEUTEL:	NEE
PROFIEL:	BM2 - HU92
MODEL:	3 KNOPPEN
MODELLEN:	F SERIE CAS4 SYSTEMEN (2012-2016)

## AUTOSLEUTELS EN AFSTANDSBEDIENINGEN

AFBEELDING:	ART. NR.:	OMSCHRIJVING:
-------------	-----------	---------------

### BMW

#### BMW



BMW-  
R004

#### EIGENSCHAPPEN:

TRANSPONDER:	PCF7953 (HITAG PRO)
KEYLESS:	JA
FREQUENTIE	868 MHZ
BATTERIJ:	CR2450
ORIGINELE NUMMER:	
NOODSLEUTEL:	JA
PROFIEL:	BM2 - HU92
MODEL:	3 KNOPPEN
MODELLEN:	F SERIE CAS4 SYSTEMEN (2012-2016)



BMW-  
R005

#### EIGENSCHAPPEN:

TRANSPONDER:	NEE
KEYLESS:	433 MHZ
FREQUENTIE	CRCR2025 SOLDEREN OF CR2032
BATTERIJ:	
ORIGINELE NUMMER:	NEE
NOODSLEUTEL:	BM2 - HU92
PROFIEL:	
MODEL:	
MODELLEN:	X5 (2002-2006)
	3 SERIE (2005+) Z4 (2002-2009)
	5 SERIE (2002-2003)
	X3 (2004-2010)

#### BMW



BMW-  
R006

#### EIGENSCHAPPEN:

TRANSPONDER:	PCF 7953P (HITAG PRO)
KEYLESS:	JA
FREQUENTIE	434 MHZ
BATTERIJ:	CR2032
ORIGINELE NUMMER:	
NOODSLEUTEL:	JA
PROFIEL:	BM2 - HU92
MODEL:	3 KNOPPEN
MODELLEN:	BMW 9337244-01
	BMW 9337240-01 BMW 9337242-01
	5AF 011926-11 ID:2013DJ5983

## AUTOSLEUTELS EN AFSTANDBEDIENINGEN

AFBEELDING:

ART. NR.:

OMSCHRIJVING:

### CHEVROLET

CHEVROLET

EIGENSCHAPPEN:



CHE-R001

<b>TRANSPONDER:</b>	ID46 HITAG2
<b>KEYLESS:</b>	JA
<b>FREQUENTIE</b>	434 MHZ
<b>BATTERIJ:</b>	CR2032
<b>ORIGINELE NUMMER:</b>	
	HYQ4EA PN 13590048, 13508769
	13584497 13589533
<b>NOODSLEUTEL:</b>	
<b>PROFIEL:</b>	VX5-HU100
<b>MODEL:</b>	4 KNOPPEN + PANIEK
<b>MODELLEN:</b>	MALIBU 2016+
	CRUZE 2016+ CAMARO 2016+

## AUTOSLEUTELS EN AFSTANDSBEDIENINGEN

AFBEELDING:	ART. NR.:	OMSCHRIJVING:
-------------	-----------	---------------

### CHRYSLER

#### CHRYSLER



CHR-R001

#### EIGENSCHAPPEN:

TRANSPONDER:	PCF7961
KEYLESS:	NEE
FREQUENTIE	433 MHZ
BATTERIJ:	CR2032
ORIGINELE NUMMER:	M3N5WY783X
NOODSLEUTEL:	JA
PROFIEL:	
MODEL:	
MODELLEN:	3 KNOPPEN + PANIEK

#### CHRYSLER



CHR-R002

#### EIGENSCHAPPEN:

TRANSPONDER:	PCF7961
KEYLESS:	NEE
FREQUENTIE	433 MHZ
BATTERIJ:	CR2032
ORIGINELE NUMMER:	M3N5WY783X
NOODSLEUTEL:	JA
PROFIEL:	
MODEL:	
MODELLEN:	4 KNOPPEN + PANIEK

#### CHRYSLER



CHR-R003

#### EIGENSCHAPPEN:

TRANSPONDER:	PCF7961
KEYLESS:	NEE
FREQUENTIE	433 MHZ
BATTERIJ:	CR2032
ORIGINELE NUMMER:	M3N5WY783X
NOODSLEUTEL:	JA
PROFIEL:	
MODEL:	
MODELLEN:	3 KNOPPEN + PANIEK

## AUTOSLEUTELS EN AFSTANDSBEDIENINGEN

AFBEELDING:	ART. NR.:	OMSCHRIJVING:
-------------	-----------	---------------

### CHRYSLER

CHRYSLER



CHR-R004

EIGENSCHAPPEN:

TRANSPONDER:	PCF7961
KEYLESS:	NEE
FREQUENTIE	433 MHZ
BATTERIJ:	CR2032
ORIGINELE NUMMER:	M3N5WY783X
NOODSLEUTEL:	JA
PROFIEL:	
MODEL:	
MODELLEN:	6 KNOPPEN + PANIEK

CHRYSLER



CHR-R005

EIGENSCHAPPEN:

TRANSPONDER:	PCF7961
KEYLESS:	NEE
FREQUENTIE	434 MHZ
BATTERIJ:	
ORIGINELE NUMMER:	
NOODSLEUTEL:	NEE
PROFIEL:	CY16
MODEL:	3 KNOPPEN
MODELLEN:	

CHRYSLER / JEEP



JEE-R001

EIGENSCHAPPEN:

TRANSPONDER:	48 AES
KEYLESS:	NEE
FREQUENTIE	434 MHZ
BATTERIJ:	
ORIGINELE NUMMER:	
NOODSLEUTEL:	JA
PROFIEL:	
MODEL:	6 KNOPPEN + PANIEK
MODELLEN:	JEEP RENEGADE

CITROËN --> ZIE PSA

## AUTOSLEUTELS EN AFSTANDSBEDIENINGEN

AFBEELDING:	ART. NR.:	OMSCHRIJVING:
-------------	-----------	---------------

### DACIA

#### DACIA



#### DACIA



#### DACIA



#### EIGENSCHAPPEN:

<b>TRANSPONDER:</b>	ID46 PCF7946
<b>KEYLESS:</b>	NEE
<b>FREQUENTIE</b>	433 MHZ
<b>BATTERIJ:</b>	CR2032
<b>ORIGINELE NUMMER:</b>	
<b>NOODSLEUTEL:</b>	NEE
<b>PROFIEL:</b>	PG33 - VA2
<b>MODEL:</b>	2 KNOPPEN
<b>MODELLEN:</b>	SANDERO (2009-2012) DUSTER 2010-2012)
	LOGAN (2005-2010)

REN-R008

#### EIGENSCHAPPEN:

<b>TRANSPONDER:</b>	ID47 PCF7939 PH.CR.3
	HITAG-AES
<b>KEYLESS:</b>	NEE
<b>FREQUENTIE</b>	433 MHZ
<b>BATTERIJ:</b>	CR2016
<b>ORIGINELE NUMMER:</b>	
<b>PROFIEL:</b>	VE20 -VAC102
<b>MODEL:</b>	3 KNOPPEN
<b>MODELLEN:</b>	DUSTER (2013-2016) SANDERO (2013-2016)
	LOGAN (2013-2016) DOKKER (2013+)

REN-R009

#### EIGENSCHAPPEN:

<b>TRANSPONDER:</b>	ID46 PCF7946
<b>KEYLESS:</b>	NEE
<b>FREQUENTIE</b>	433 MHZ
<b>BATTERIJ:</b>	CR2016
<b>ORIGINELE NUMMER:</b>	
<b>NOODSLEUTEL:</b>	NEE
<b>PROFIEL:</b>	VE20 - VAC102
<b>MODEL:</b>	3 KNOPPEN
<b>MODELLEN:</b>	DUSTER (-2012) LOGAN (-2012)
	SANDERO (-2012)

REN-R010

## AUTOSLEUTELS EN AFSTANDSBEDIENINGEN

AFBEELDING:	ART. NR.:	OMSCHRIJVING:
-------------	-----------	---------------

### DACIA



#### EIGENSCHAPPEN:

**TRANSPONDER:** ID47 PCF7939 PH.CR.3

HITAG/AES

**FREQUENTIE** 433 MHZ

**BATTERIJ:** CR2016

**ORIGINELE NUMMER:**

**NOODSLEUTEL:** NEE

**PROFIEL:** VE20 - VAC2

**MODEL:** 2 KNOPPEN

**MODELLEN:**

DUSTER (2013-2016) SANDERO (2013-2016)

LOGAN (2013-2016) DOKKER (2013+)



#### EIGENSCHAPPEN:

**TRANSPONDER:** ID46 PCF7946

**KEYLESS:** NEE

**FREQUENTIE** 433 MHZ

**BATTERIJ:** CR2016

**REN-R016 NOODSLEUTEL:** NEE

**ORIGINELE NUMMER:**

**PROFIEL:** VE20 - VAC2

**MODEL:** 2 KNOPPEN

**MODELLEN:**

DUSTER (-2012) SANDERO (-2012)

LOGAN (-2012)

DACIA



#### EIGENSCHAPPEN:

**TRANSPONDER:** ID46 PCF7947

**KEYLESS:** NEE

**FREQUENTIE** 433 MHZ

**BATTERIJ:** CR2016

**REN-R017 ORIGINELE NUMMER:** NEE

**NOODSLEUTEL:**

**PROFIEL:** VE20 - VAC2

**MODEL:** 2 KNOPPEN

**MODELLEN:**

DUSTER SANDERO

LOGAN



## AUTOSLEUTELS EN AFSTANDSBEDIENINGEN

AFBEELDING:	ART. NR.:	OMSCHRIJVING:
-------------	-----------	---------------

### DACIA

DACIA



REN-R018

#### EIGENSCHAPPEN:

<b>TRANSPONDER:</b>	PCF7939 HITAG AES 128 (PCF7961M)
<b>KEYLESS:</b>	NEE
<b>FREQUENTIE</b>	433 MHZ
<b>BATTERIJ:</b>	CR2016
<b>ORIGINELE NUMMER:</b>	
<b>NOODSLEUTEL:</b>	NEE
<b>PROFIEL:</b>	
<b>MODEL:</b>	3 KNOPPEN
<b>MODELLEN:</b>	DUSTER (2013-CR2016) SANDERO (2013-CR2016) LOGAN (2013-CR2016)

DACIA



REN-R019

#### EIGENSCHAPPEN:

<b>TRANSPONDER:</b>	PCF7961M
<b>KEYLESS:</b>	NEE
<b>FREQUENTIE</b>	433 MHZ
<b>BATTERIJ:</b>	CR2016
<b>ORIGINELE NUMMER:</b>	
<b>PROFIEL:</b>	
<b>MODEL:</b>	2 KNOPPEN
<b>MODELLEN:</b>	DUSTER (2013-2016) SANDERO (2013-2016) LOGAN (2013-2016)

## AUTOSLEUTELS EN AFSTANDBEDIENINGEN

AFBEELDING:	ART. NR.:	OMSCHRIJVING:
-------------	-----------	---------------

FIAT

FIAT



FIA-R001

### EIGENSCHAPPEN:

<b>TRANSPONDER:</b>	DELPHI PCF 7946
<b>KEYLESS:</b>	NEE
<b>FREQUENTIE</b>	433 MHZ
<b>BATTERIJ:</b>	CR2032
<b>ORIGINELE NUMMER:</b>	
<b>NOODSLEUTEL:</b>	NEE
<b>PROFIEL:</b>	FT22 - SIP22
<b>MODEL:</b>	3 KNOPPEN
<b>MODELLEN:</b>	BODY CONTROL MOD. BSI
FIORINO (2007-2016)	500 (2007-2016)
DOBLO (2010-2016)	CITROEN NEMO ('07-'16)
PUNTO (2012-CR2016)	PEUGEOT BIPPER ('07-'16)
PUNTO EVO (2010-2012)	
GRANDE PUNTO (2006-2010)	
QUBO (2008-2016)	

FIAT



FIA-R002

### EIGENSCHAPPEN:

<b>TRANSPONDER:</b>	MARELLI PCF 7946
<b>KEYLESS:</b>	NEE
<b>FREQUENTIE</b>	433 MHZ
<b>BATTERIJ:</b>	CR2032
<b>ORIGINELE NUMMER:</b>	
<b>NOODSLEUTEL:</b>	NEE
<b>PROFIEL:</b>	FT22 - SIP22
<b>MODEL:</b>	3 KNOPPEN
<b>MODELLEN:</b>	BODY CONTROL MOD. BSI
BRAVO (2010-2016)	IVECO DAILY (2012+)
DUCATO (2010-2016)	LANCIA MUSA ('09-'12)
500/500L (2012-2016)	
CITROEN JUMPER (2010-2016)	
CITROEN RELAY (2010-2016)	
PEUGEOT BOXER (2010-2016)	
ALFA ROMEO GUILIETTA (2011+)	

## AUTOSLEUTELS EN AFSTANDSBEDIENINGEN

AFBEELDING:	ART. NR.:	OMSCHRIJVING:
-------------	-----------	---------------

### FIAT

#### FIAT FREEMONT KEYLESS



FIA-R003

#### EIGENSCHAPPEN:

<b>TRANSPONDER:</b>	PCF 7945 / 7953 HITAG2
<b>KEYLESS:</b>	JA
<b>FREQUENTIE</b>	434 MHZ
<b>BATTERIJ:</b>	CR2032
<b>ORIGINELE NUMMER:</b>	M3N40821302
<b>NOODSLEUTEL:</b>	JA
<b>PROFIEL:</b>	FT22 - SIP22
<b>MODEL:</b>	3 KNOPPEN
<b>MODELLEN:</b>	FREEMONT (2010+)

#### FIAT LINEA



FIA-R005

#### EIGENSCHAPPEN:

<b>TRANSPONDER:</b>	ID48
<b>KEYLESS:</b>	NEE
<b>FREQUENTIE</b>	
<b>BATTERIJ:</b>	CR2032
<b>ORIGINELE NUMMER:</b>	71749162
<b>NOODSLEUTEL:</b>	NEE
<b>PROFIEL:</b>	FT22 - SIP22
<b>MODEL:</b>	3 KNOPPEN
<b>MODELLEN:</b>	LINEA (2007) IVECO DAILY (-2007) BRAVO (2007) IVECO EURO CARGO (-'07) PUNTO (2007) CITROËN JUMPER (2006) STILO (2007) CITROËN RELAY (2006) LANCIA YPSILON (2007) PEUGEOT BOXER (-2007)

## AUTOSLEUTELS EN AFSTANDBEDIENINGEN

AFBEELDING:	ART. NR.:	OMSCHRIJVING:
-------------	-----------	---------------

### FIAT

FIAT



FIA-R006

#### EIGENSCHAPPEN:

<b>TRANSPONDER:</b>	ID48 AES
<b>KEYLESS:</b>	NEE
<b>FREQUENTIE</b>	433 MHZ
<b>BATTERIJ:</b>	CR2032
<b>ORIGINELE NUMMER:</b>	
<b>NOODSLEUTEL:</b>	NEE
<b>PROFIEL:</b>	FT22 - SIP22
<b>MODEL:</b>	3 KNOPPEN
<b>MODELLEN:</b>	
EGEA (2015+)	500X (2015+)
TIPO (2015+)	

FIAT



FIA-R007

#### EIGENSCHAPPEN:

<b>TRANSPONDER:</b>	ID48
<b>KEYLESS:</b>	NEE
<b>FREQUENTIE</b>	433 MHZ
<b>BATTERIJ:</b>	CR2032
<b>ORIGINELE NUMMER:</b>	
<b>NOODSLEUTEL:</b>	NEE
<b>PROFIEL:</b>	FT22 - SIP22
<b>MODEL:</b>	1 KNOP
<b>MODELLEN:</b>	
DOBLO (2001-2008)	
PUNTO 188 (1999-2010)	

## AUTOSLEUTELS EN AFSTANDSBEDIENINGEN

AFBEELDING:	ART. NR.:	OMSCHRIJVING:
-------------	-----------	---------------

### FORD

#### FORD



FOR-R001

#### EIGENSCHAPPEN:

<b>TRANSPONDER:</b>	4D63 80 BIT
<b>KEYLESS:</b>	NEE
<b>FREQUENTIE</b>	434 MHZ
<b>BATTERIJ:</b>	CR2032
<b>ORIGINELE NUMMER:</b>	2010DJ1445
<b>NOODSLEUTEL:</b>	NEE
<b>PROFIEL:</b>	FD40 - HU101
<b>MODEL:</b>	3 KNOPPEN
<b>MODELLEN:</b>	
FOCUS (2011-2013)	C-MAX (2010-2014)
MONDEO (2011-2014)	GRAND C-MAX ('10-'14)
S-MAX (2013)	TRANSIT CONNECT (2013)

#### FORD MONDEO



FOR-R002

#### EIGENSCHAPPEN:

<b>TRANSPONDER:</b>	PCF 7953
<b>KEYLESS:</b>	JA
<b>FREQUENTIE</b>	434 MHZ
<b>BATTERIJ:</b>	CR2032
<b>ORIGINELE NUMMER:</b>	DS7T-15K601B
<b>NOODSLEUTEL:</b>	JA
<b>PROFIEL:</b>	
<b>MODEL:</b>	3 KNOPPEN
<b>MODELLEN:</b>	
MONDEO 2014+	KA 2016+
GALAXY 2015+	S-MAX 2015+

#### FORD



FOR-R004

#### EIGENSCHAPPEN:

<b>TRANSPONDER:</b>	PCF 7945P HITAG PRO
<b>KEYLESS:</b>	NEE
<b>FREQUENTIE</b>	433 MHZ
<b>BATTERIJ:</b>	CR2032
<b>ORIGINELE NUMMER:</b>	
<b>NOODSLEUTEL:</b>	NEE
<b>PROFIEL:</b>	FD40 - HU101
<b>MODEL:</b>	3 KNOPPEN
<b>MODELLEN:</b>	
FOCUS (2015+)	

## AUTOSLEUTELS EN AFSTANDSBEDIENINGEN

AFBEELDING:	ART. NR.:	OMSCHRIJVING:
-------------	-----------	---------------

### FORD

#### FORD KEYLESS



FOR-R005

#### EIGENSCHAPPEN:

TRANSPONDER:	PCF 7953P HITAG PRO
KEYLESS:	JA
FREQUENTIE	433 MHZ
BATTERIJ:	CR2032
ORIGINELE NUMMER:	
NOODSLEUTEL:	JA
PROFIEL:	
MODEL:	3 KNOPPEN
MODELLEN:	
FOCUS (2013+)	
FIESTA	

#### FORD KEYLESS



FOR-R006

#### EIGENSCHAPPEN:

TRANSPONDER:	ID63 80 BIT
KEYLESS:	JA
FREQUENTIE	434 MHZ
BATTERIJ:	CR2032
ORIGINELE NUMMER:	
NOODSLEUTEL:	JA
PROFIEL:	
MODEL:	3 KNOPPEN
MODELLEN:	
FOCUS (2009-2013)	
FIESTA (2009-2013)	

#### FORD



FOR-R007

#### EIGENSCHAPPEN:

TRANSPONDER:	4D 60 80 BIT
KEYLESS:	NEE
FREQUENTIE	434 MHZ
BATTERIJ:	CR2032
ORIGINELE NUMMER:	
NOODSLEUTEL:	NEE
PROFIEL:	FD40 - HU101
MODEL:	3 KNOPPEN
MODELLEN:	
FOCUS 2002+	FIESTA 2002+
FUSION 2002+	MONDEO 2002+

## AUTOSLEUTELS EN AFSTANDSBEDIENINGEN

AFBEELDING:	ART. NR.:	OMSCHRIJVING:
-------------	-----------	---------------

### FORD

#### FORD



FOR-R008

#### EIGENSCHAPPEN:

TRANSPONDER:	4D 60 80 BIT
KEYLESS:	NEE
FREQUENTIE	434 MHZ
BATTERIJ:	CR2032
ORIGINELE NUMMER:	
NOODSLEUTEL:	NEE
PROFIEL:	NEE
MODEL:	FD3 - FO21
MODELLEN:	3 KNOPPEN
FOCUS 2002+	FIESTA 2002+
FUSION 2002+	MONDEO 2002+

#### FORD



FOR-R009

#### EIGENSCHAPPEN:

TRANSPONDER:	ID63
KEYLESS:	NEE
FREQUENTIE	433 MHZ
BATTERIJ:	CR2032
ORIGINELE NUMMER:	
NOODSLEUTEL:	NEE
PROFIEL:	FD40 - HU101
MODEL:	3 KNOPPEN
MODELLEN:	
FOCUS 2007+	C MAX 2007+
B MAX 2007+	

## AUTOSLEUTELS EN AFSTANDSBEDIENINGEN

AFBEELDING:	ART. NR.:	OMSCHRIJVING:
-------------	-----------	---------------

### HYUNDAI

#### HYUNDAI I30 / IX20



HYU-R001

#### EIGENSCHAPPEN:

TRANSPONDER:	ID60 80 BIT (EXCLUSIEF)
KEYLESS:	NEE
FREQUENTIE	433 MHZ
BATTERIJ:	CR2032
ORIGINELE NUMMER:	
NOODSLEUTEL:	NEE
PROFIEL:	HYN13
MODEL:	3 KNOPPEN
MODELLEN:	
	I30 (12.2011-02-2015)
	1X20 (2012-2014)

#### HYUNDAI KEYLESS



HYU-R002

#### EIGENSCHAPPEN:

TRANSPONDER:	ID46 PCF7952
KEYLESS:	JA
FREQUENTIE	433 MHZ
BATTERIJ:	CR2032
ORIGINELE NUMMER:	2010DJ1689
NOODSLEUTEL:	JA
PROFIEL:	
MODEL:	3 KNOPPEN
MODELLEN:	
	I30 (2012-2014) TUCSON (2010-2013)
	IX35 (2010-2013)

#### HYUNDAI KEYLESS



HYU-R003

#### EIGENSCHAPPEN:

TRANSPONDER:	ID46 PCF7945/7953
KEYLESS:	JA
FREQUENTIE	433 MHZ
BATTERIJ:	CR2032
ORIGINELE NUMMER:	
NOODSLEUTEL:	JA
PROFIEL:	
MODEL:	3 KNOPPEN
MODELLEN:	
	IX35 (2013+)



## AUTOSLEUTELS EN AFSTANDSBEDIENINGEN

AFBEELDING:	ART. NR.:	OMSCHRIJVING:
-------------	-----------	---------------

### HYUNDAI

#### HYUNDAI I20



#### EIGENSCHAPPEN:

<b>TRANSPONDER:</b>	4D-60-80 BIT (EXCLUSIEF)
<b>KEYLESS:</b>	NEE
<b>FREQUENTIE</b>	433 MHZ
<b>BATTERIJ:</b>	CR2032
<b>HYU-R004 ORIGINELE NUMMER:</b>	
<b>NOODSLEUTEL:</b>	NEE
<b>PROFIEL:</b>	HYN13
<b>MODEL:</b>	3 KNOPPEN
<b>MODELLEN:</b>	I20 (-2015)

#### HYUNDAI I10



#### EIGENSCHAPPEN:

<b>TRANSPONDER:</b>	HITAG3 (EXCLUSIEF)
<b>KEYLESS:</b>	NEE
<b>FREQUENTIE</b>	433 MHZ
<b>BATTERIJ:</b>	CR2032
<b>HYU-R005 ORIGINELE NUMMER:</b>	
<b>NOODSLEUTEL:</b>	NEE
<b>PROFIEL:</b>	HYN13
<b>MODEL:</b>	3 KNOPPEN
<b>MODELLEN:</b>	I10 (2013+)

#### HYUNDAI I20



#### EIGENSCHAPPEN:

<b>TRANSPONDER:</b>	PCF7936 (EXCLUSIEF)
<b>KEYLESS:</b>	NEE
<b>FREQUENTIE</b>	433 MHZ
<b>BATTERIJ:</b>	CR2032
<b>HYU-R006 ORIGINELE NUMMER:</b>	
<b>NOODSLEUTEL:</b>	NEE
<b>PROFIEL:</b>	HYN13
<b>MODEL:</b>	3 KNOPPEN
<b>MODELLEN:</b>	I20 (2013)

## AUTOSLEUTELS EN AFSTANDSBEDIENINGEN

AFBEELDING:	ART. NR.:	OMSCHRIJVING:
-------------	-----------	---------------

### HYUNDAI

#### HYUNDAI I20



HYU-R008

#### EIGENSCHAPPEN:

TRANSPONDER:	HITAG3 (EXCLUSIEF)
KEYLESS:	NEE
FREQUENTIE	433 MHZ
BATTERIJ:	CR2032
ORIGINELE NUMMER:	
NOODSLEUTEL:	JA
PROFIEL:	HYN13
MODEL:	3 KNOPPEN
MODELLEN:	I20 (2015+)

#### HYUNDAI IX35 KEYLESS



HYU-R009

#### EIGENSCHAPPEN:

TRANSPONDER:	ID46 PCF7952A
KEYLESS:	JA
FREQUENTIE	433 MHZ
BATTERIJ:	CR2032
ORIGINELE NUMMER:	
NOODSLEUTEL:	JA
PROFIEL:	
MODEL:	3 KNOPPEN
MODELLEN:	IX35 (2011-2014) VELOSTER (2012-2016) GENESIS (2009-2012) SONATA (2011-2014)

#### HYUNDAI I20



HYU-R011

#### EIGENSCHAPPEN:

TRANSPONDER:	PCF7936 (EXCLUSIEF)
KEYLESS:	NEE
FREQUENTIE	433 MHZ
BATTERIJ:	CR2032
ORIGINELE NUMMER:	
NOODSLEUTEL:	NEE
PROFIEL:	HYN13
MODEL:	3 KNOPPEN
MODELLEN:	I20 (2014+)

## AUTOSLEUTELS EN AFSTANDSBEDIENINGEN

AFBEELDING:	ART. NR.:	OMSCHRIJVING:
-------------	-----------	---------------

### HYUNDAI

#### HYUNDAI



#### EIGENSCHAPPEN:

<b>TRANSPONDER:</b>	PCF7936
<b>KEYLESS:</b>	NEE
<b>FREQUENTIE</b>	433 MHZ
<b>BATTERIJ:</b>	CR2032
<b>ORIGINELE NUMMER:</b>	
<b>HYU-R012 NOODSLEUTEL:</b>	NEE
<b>PROFIEL:</b>	
<b>MODEL:</b>	1 KNOP
<b>MODELLEN:</b>	
	HYUNDAI (2014+)

#### HYUNDAI



#### EIGENSCHAPPEN:

<b>TRANSPONDER:</b>	PCF7936
<b>KEYLESS:</b>	NEE
<b>FREQUENTIE</b>	433 MHZ
<b>BATTERIJ:</b>	CR2032
<b>ORIGINELE NUMMER:</b>	
<b>HYU-R013 NOODSLEUTEL:</b>	NEE
<b>PROFIEL:</b>	
<b>MODEL:</b>	1 KNOP
<b>MODELLEN:</b>	
	HYUNDAI (2014+)

---

**AUTOSLEUTELS EN AFSTANDSBEDIENINGEN**

---

AFBEELDING:

ART. NR.:

OMSCHRIJVING:

---

---

---

**IVECO --> ZIE FIAT**

---

**JEEP --> ZIE CHRYSLER**

---

## AUTOSLEUTELS EN AFSTANDSBEDIENINGEN

AFBEELDING:	ART. NR.:	OMSCHRIJVING:
-------------	-----------	---------------

### KIA

#### KIA KEYLESS



KIA-R001

#### EIGENSCHAPPEN:

TRANSPONDER:	ID46 PCF7952
KEYLESS:	JA
FREQUENTIE	433 MHZ
BATTERIJ:	CR2032
ORIGINELE NUMMER:	
NOODSLEUTEL:	JA
PROFIEL:	
MODEL:	3 KNOPPEN
MODELLEN:	
	SORRENTO (2012-2015)
	SPORTAGE (2012-2015)

#### KIA SPORTAGE



KIA-R002

#### EIGENSCHAPPEN:

TRANSPONDER:	4D-60-60 BIT (EXCLUSIEF)
KEYLESS:	NEE
FREQUENTIE	433 MHZ
BATTERIJ:	CR2032
ORIGINELE NUMMER:	
NOODSLEUTEL:	NEE
PROFIEL:	
MODEL:	3 KNOPPEN
MODELLEN:	
	SPORTAGE (2015+)

#### KIA



KIA-R003

#### EIGENSCHAPPEN:

TRANSPONDER:	ID46 PCF7936 (EXCLUSIEF)
KEYLESS:	NEE
FREQUENTIE	433 MHZ
BATTERIJ:	
ORIGINELE NUMMER:	
NOODSLEUTEL:	NEE
PROFIEL:	
MODEL:	
MODELLEN:	
	KIA (2008+)

## AUTOSLEUTELS EN AFSTANDBEDIENINGEN

AFBEELDING:

ART. NR.:

OMSCHRIJVING:

**LANCIA --> ZIE FIAT**

## LAND ROVER

LAND ROVER DISCOVERY 3

EIGENSCHAPPEN:



LAN-R001

<b>TRANSPONDER:</b>	PCF7941
<b>KEYLESS:</b>	NEE
<b>FREQUENTIE</b>	434 MHZ
<b>BATTERIJ:</b>	CR2032 SOLDEREN
<b>ORIGINELE NUMMER:</b>	
<b>NOODSLEUTEL:</b>	NEE
<b>PROFIEL:</b>	FD40 - HU101
<b>MODEL:</b>	3 KNOPPEN
<b>MODELLEN:</b>	
LAND ROVER (2004-2009)	

LAND ROVER



LAN-R002

EIGENSCHAPPEN:

<b>TRANSPONDER:</b>	ID46 PCF7945/7953
<b>KEYLESS:</b>	JA
<b>FREQUENTIE</b>	433 MHZ
<b>BATTERIJ:</b>	CR2032
<b>ORIGINELE NUMMER:</b>	
<b>NOODSLEUTEL:</b>	JA
<b>PROFIEL:</b>	FD40 - HU101
<b>MODEL:</b>	5 KNOPPEN
<b>MODELLEN:</b>	
FREELANDER (2007-2012)	

## AUTOSLEUTELS EN AFSTANDBEDIENINGEN

AFBEELDING:	ART. NR.:	OMSCHRIJVING:
-------------	-----------	---------------

### LAND ROVER

#### LAND ROVER RANGE ROVER



LAN-R003

#### EIGENSCHAPPEN:

TRANSPONDER:	ID46 PCF7953
KEYLESS:	JA
FREQUENTIE	434 MHZ
BATTERIJ:	CR2032
ORIGINELE NUMMER:	
NOODSLEUTEL:	JA
PROFIEL:	FD40 - HU101
MODEL:	5 KNOPPEN
MODELLEN:	
	RANGE ROVER SPORT EVOQUE (-CR2016)

### MASERATI

#### MASERATI



MAS-R001

#### EIGENSCHAPPEN:

TRANSPONDER:	PCF7945/7953 HITAG2
KEYLESS:	JA
FREQUENTIE	434 MHZ
BATTERIJ:	CR2032
ORIGINELE NUMMER:	
NOODSLEUTEL:	JA
PROFIEL:	
MODEL:	4 KNOPPEN
MODELLEN:	
	MASERATI (2014-2018)

## AUTOSLEUTELS EN AFSTANDSBEDIENINGEN

AFBEELDING:	ART. NR.:	OMSCHRIJVING:
-------------	-----------	---------------

### MAZDA

#### MAZDA 3



MAZ-  
R001

#### EIGENSCHAPPEN:

TRANSPONDER:	ID46
KEYLESS:	NEE
FREQUENTIE	433 MHZ
BATTERIJ:	CR1620
ORIGINELE NUMMER:	
NOODSLEUTEL:	NEE
PROFIEL:	MZ24 - MAZ24R
MODEL:	3 KNOPPEN
MODELLEN:	
3 (-2010)	AB HANDMATIG PROGRAMMEREN

#### MAZDA 3 / 6



MAZ-  
R002

#### EIGENSCHAPPEN:

TRANSPONDER:	ID63
KEYLESS:	NEE
FREQUENTIE	433 MHZ
BATTERIJ:	CR1620
ORIGINELE NUMMER:	
NOODSLEUTEL:	NEE
PROFIEL:	MZ24 - MAZ24R
MODEL:	2 KNOPPEN
MODELLEN:	
3 (2010+)	AB HANDMATIG
6 (2010+)	PROGRAMMEREN

#### MAZDA 2 / 5



MAZ-  
R003

#### EIGENSCHAPPEN:

TRANSPONDER:	49 HITAG PRO
KEYLESS:	JA
FREQUENTIE	433 MHZ
BATTERIJ:	CR2032
ORIGINELE NUMMER:	
NOODSLEUTEL:	JA
PROFIEL:	MZ24 - MAZ24R
MODEL:	2 KNOPPEN
MODELLEN:	
2 (2014+)	
5 (2014+)	



## AUTOSLEUTELS EN AFSTANDSBEDIENINGEN

AFBEELDING:	ART. NR.:	OMSCHRIJVING:
-------------	-----------	---------------

### MERCEDES

#### MERCEDES NEC-BGA



MER-R001

#### EIGENSCHAPPEN:

<b>TRANSPONDER:</b>	FBS3 NEC BGA
<b>KEYLESS:</b>	
<b>FREQUENTIE</b>	433 MHZ
<b>BATTERIJ:</b>	CR2025
<b>ORIGINELE NUMMER:</b>	
<b>NOODSLEUTEL:</b>	JA
<b>PROFIEL:</b>	MB57 - HU64
<b>MODEL:</b>	3 KNOPPEN
<b>MODELLEN:</b>	W202, W203, W204, W210, W220 (1999-2015)

#### MERCEDES NEC-BGA



MER-R002

#### EIGENSCHAPPEN:

<b>TRANSPONDER:</b>	FBS3 NEC BGA
<b>KEYLESS:</b>	JA
<b>FREQUENTIE</b>	433 MHZ
<b>BATTERIJ:</b>	CR2025
<b>ORIGINELE NUMMER:</b>	
<b>NOODSLEUTEL:</b>	JA
<b>PROFIEL:</b>	MB57 - HU64
<b>MODEL:</b>	2 KNOPPEN
<b>MODELLEN:</b>	2 KNOPPEN (2005-2015)



MER-R03ZF



MER-R121

**AUTOSLEUTELS EN AFSTANDSBEDIENINGEN**

AFBEELDING:	ART. NR.:	OMSCHRIJVING:
-------------	-----------	---------------

**MERCEDES**



**MER-  
R122**



**MER-  
R123**



**MER-  
R124**



**MER-  
R125**

**NOODSLEUTEL MERCEDES**



**MER-R020B**



**MER-R021C**



**MER-R037B**



**MER-021B**

## AUTOSLEUTELS EN AFSTANDSBEDIENINGEN

AFBEELDING:	ART. NR.:	OMSCHRIJVING:
-------------	-----------	---------------

### MINI

#### MINI COOPER



MIN-R001

#### EIGENSCHAPPEN:

<b>TRANSPONDER:</b>	ID33 PCF7935
<b>KEYLESS:</b>	NEE
<b>FREQUENTIE</b>	433 MHZ
<b>BATTERIJ:</b>	2020/CR2025 SOLDEREN OF CR2032 NORMAAL
<b>NOODSLEUTEL:</b>	NEE
<b>PROFIEL:</b>	PG33 - VA2
<b>MODEL:</b>	2 KNOPPEN
<b>MODELLEN:</b>	
COOPER (2004+)	COOPER D (2005+)
COOPER ONE ('05+)	COOPER S (2005+)

#### MINI COOPER



MIN-R002

#### EIGENSCHAPPEN:

<b>TRANSPONDER:</b>	ID33 PCF7935
<b>KEYLESS:</b>	NEE
<b>FREQUENTIE</b>	434 MHZ
<b>BATTERIJ:</b>	
<b>ORIGINELE NUMMER:</b>	
<b>NOODSLEUTEL:</b>	NEE
<b>PROFIEL:</b>	PG33 - VA2
<b>MODEL:</b>	2 KNOPPEN
<b>MODELLEN:</b>	
COOPER (1999-2004)	COOPER D (1998-2005)
COOPER ONE ('01-'05)	COOPER S (2001-2005)

#### MINI COOPER



MIN-R003

#### EIGENSCHAPPEN:

<b>TRANSPONDER:</b>	
<b>KEYLESS:</b>	JA
<b>FREQUENTIE</b>	868 MHZ
<b>BATTERIJ:</b>	
<b>ORIGINELE NUMMER:</b>	
<b>NOODSLEUTEL:</b>	JA
<b>PROFIEL:</b>	PG33 - VA2
<b>MODEL:</b>	3 KNOPPEN
<b>MODELLEN:</b>	
MINI COOPER	

## AUTOSLEUTELS EN AFSTANDSBEDIENINGEN

AFBEELDING:	ART. NR.:	OMSCHRIJVING:
-------------	-----------	---------------

### MITSUBISHI

#### MITSUBISHI KEYLESS



MIT-R001

#### EIGENSCHAPPEN:

TRANSPONDER:	PCF7952C
KEYLESS:	JA
FREQUENTIE	433 MHZ
BATTERIJ:	
ORIGINELE NUMMER:	2012DJ3230
NOODSLEUTEL:	JA
PROFIEL:	MT1 - MIT8
MODEL:	3 KNOPPEN
MODELLEN:	
OUTLANDER 01.2012-08.2015)	

### NISSAN

#### NISSAN



NIS-R001

#### EIGENSCHAPPEN:

TRANSPONDER:	PCF7953 HITAG AES
KEYLESS:	JA
FREQUENTIE	433 MHZ
BATTERIJ:	CR2032
ORIGINELE NUMMER:	
NOODSLEUTEL:	JA
PROFIEL:	
MODEL:	3 KNOPPEN
MODELLEN:	
QASHQAI (2012+)	

#### NISSAN KEYLESS



NIS-R002

#### EIGENSCHAPPEN:

TRANSPONDER:	4D60
KEYLESS:	JA
FREQUENTIE	433 MHZ
BATTERIJ:	CR2032
ORIGINELE NUMMER:	285E3C9920, 285E3BC400, 285E3EB40A
NOODSLEUTEL:	JA
PROFIEL:	NS34 - NSN14
MODEL:	2 KNOPPEN
MODELLEN:	
MICRA K12 (8.'03-'08)	QASHQAI (4.2007-2014)
NOTE E11 (2006-2013)	X-TRAIL 5.2007-7.2015)

## AUTOSLEUTELS EN AFSTANDSBEDIENINGEN

AFBEELDING:	ART. NR.:	OMSCHRIJVING:
-------------	-----------	---------------

### NISSAN

#### NISSAN KEYLESS



NIS-R003

#### EIGENSCHAPPEN:

<b>TRANSPONDER:</b>	ID46 PCF7936
<b>KEYLESS:</b>	JA
<b>FREQUENTIE</b>	433 MHZ
<b>BATTERIJ:</b>	CR2032
<b>ORIGINELE NUMMER:</b>	
<b>NOODSLEUTEL:</b>	JA
<b>PROFIEL:</b>	NS34 - NSN14
<b>MODEL:</b>	2 KNOPPEN
<b>MODELLEN:</b>	
MICRA (2014+)	NAVARA (2005+)
QASHQAI (2004+)	X-TRAIL (2005+)

#### NISSAN



NIS-R004

#### EIGENSCHAPPEN:

<b>TRANSPONDER:</b>	PCF7946
<b>KEYLESS:</b>	NEE
<b>FREQUENTIE</b>	433 MHZ
<b>BATTERIJ:</b>	CR2032
<b>ORIGINELE NUMMER:</b>	
<b>NOODSLEUTEL:</b>	NEE
<b>PROFIEL:</b>	PG33 - VA2
<b>MODEL:</b>	2 KNOPPEN
<b>MODELLEN:</b>	
MICRA (2006+)	NOTE (2006+)
NAVARA (2006+)	

#### NISSAN



NIS-R005

#### EIGENSCHAPPEN:

<b>TRANSPONDER:</b>	PCF79476
<b>KEYLESS:</b>	NEE
<b>FREQUENTIE</b>	433 MHZ
<b>BATTERIJ:</b>	CR2016
<b>ORIGINELE NUMMER:</b>	
<b>NOODSLEUTEL:</b>	NEE
<b>PROFIEL:</b>	NS34 - NSN14
<b>MODEL:</b>	2 KNOPPEN
<b>MODELLEN:</b>	
MICRA (2006+)	
QASHQAI (2006+)	

## AUTOSLEUTELS EN AFSTANDBEDIENINGEN

AFBEELDING:	ART. NR.:	OMSCHRIJVING:
-------------	-----------	---------------

### NISSAN

#### NISSAN KEYLESS



NIS-R006

#### EIGENSCHAPPEN:

<b>TRANSPONDER:</b>	ID47 PCF7945M HITAG AES
<b>KEYLESS:</b>	JA
<b>FREQUENTIE</b>	433 MHZ
<b>BATTERIJ:</b>	CR2032
<b>ORIGINELE NUMMER:</b>	2013DJ5730
<b>NOODSLEUTEL:</b>	JA
<b>PROFIEL:</b>	NS34 - NSN14
<b>MODEL:</b>	2 KNOPPEN
<b>MODELLEN:</b>	
X-TRAIL (2014-2016)	QASHQAI (2014-2017)
MURANO (2014-2016)	

#### NISSAN KEYLESS



NIS-R007

#### EIGENSCHAPPEN:

<b>TRANSPONDER:</b>	PCF7952
<b>KEYLESS:</b>	JA
<b>FREQUENTIE</b>	433 MHZ
<b>BATTERIJ:</b>	CR2032
<b>ORIGINELE NUMMER:</b>	
<b>NOODSLEUTEL:</b>	JA
<b>PROFIEL:</b>	NS34 - NSN14
<b>MODEL:</b>	2 KNOPPEN
<b>MODELLEN:</b>	
QASHQAI (2016+)	

## AUTOSLEUTELS EN AFSTANDSBEDIENINGEN

AFBEELDING:	ART. NR.:	OMSCHRIJVING:
-------------	-----------	---------------

### NISSAN

#### NISSAN MICRA / JUKE



NIS-R009

#### EIGENSCHAPPEN:

TRANSPONDER:	ID46
KEYLESS:	NEE
FREQUENTIE	433 MHZ
BATTERIJ:	CR2016
ORIGINELE NUMMER:	
NOODSLEUTEL:	NEE
PROFIEL:	NS34 - NSN14
MODEL:	2 KNOPPEN
MODELLEN:	
MICRA (2010+)	
JUKE (2010+)	

#### NISSAN



NIS-R010

#### EIGENSCHAPPEN:

TRANSPONDER:	PCF7936 HITAG 2
KEYLESS:	NEE
FREQUENTIE	433 MHZ
BATTERIJ:	CR2032
ORIGINELE NUMMER:	
NOODSLEUTEL:	NEE
PROFIEL:	NS34 - NSN14
MODEL:	3 KNOPPEN
MODELLEN:	
QASHQAI 2010+	

#### NISSAN



NIS-R011

#### EIGENSCHAPPEN:

TRANSPONDER:	PCF7961 HITAG AES
KEYLESS:	NEE
FREQUENTIE	433 MHZ
BATTERIJ:	CR2032
ORIGINELE NUMMER:	
NOODSLEUTEL:	NEE
PROFIEL:	NS34 - NSN14
MODEL:	2 KNOPPEN
MODELLEN:	
QASHQAI 2014+	
X-TRAIL 2014+	

## AUTOSLEUTELS EN AFSTANDBEDIENINGEN

AFBEELDING:	ART. NR.:	OMSCHRIJVING:
-------------	-----------	---------------

### NISSAN

NISSAN



**EIGENSCHAPPEN:**

<b>TRANSPONDER:</b>	ID46 PCF7946
<b>KEYLESS:</b>	NEE
<b>FREQUENTIE</b>	433 MHZ
<b>BATTERIJ:</b>	CR2032
<b>ORIGINELE NUMMER:</b>	
<b>REN-R008 NOODSLEUTEL:</b>	NEE
<b>PROFIEL:</b>	PG33 - VA2
<b>MODEL:</b>	2 KNOPPEN
<b>MODELLEN:</b>	
	INTERSTAR (2004-2009)
	PRIMASTAR (2004-2009)

NISSAN



**EIGENSCHAPPEN:**

<b>TRANSPONDER:</b>	ID46 PCF7946
<b>KEYLESS:</b>	NEE
<b>FREQUENTIE</b>	433 MHZ
<b>BATTERIJ:</b>	CR2032
<b>ORIGINELE NUMMER:</b>	
<b>REN-R021 NOODSLEUTEL:</b>	NEE
<b>PROFIEL:</b>	PG33 - VA2
<b>MODEL:</b>	3 KNOPPEN
<b>MODELLEN:</b>	
	KUBISTAR (2007+)
	PRIMASTAR (2007+)



## AUTOSLEUTELS EN AFSTANDSBEDIENINGEN

AFBEELDING:	ART. NR.:	OMSCHRIJVING:
-------------	-----------	---------------

### OPEL

#### OPEL



OPE-R001

#### EIGENSCHAPPEN:

<b>TRANSPONDER:</b>	ID46 PCF7952E/PCF7937
	HITAG2
<b>KEYLESS:</b>	NEE
<b>FREQUENTIE</b>	433 MHZ
<b>BATTERIJ:</b>	CR2032
<b>ORIGINELE NUMMER:</b>	
<b>NOODSLEUTEL:</b>	NEE
<b>PROFIEL:</b>	VX5 - HU100
<b>MODEL:</b>	2 KNOPPEN
<b>MODELLEN:</b>	
ASTRA J (2010-2015)	INSIGNIA (2009-2015)
CASCADA (2013-2016)	ADAM (2013-2016)
CORSA E (2014-2016)	KARL (2015-2017)
MOKKA (2013-2016)	ZAFIRA C (2012-2016)

#### OPEL VECTRA C



OPE-R002

#### EIGENSCHAPPEN:

<b>TRANSPONDER:</b>	ID46 PCF7946
<b>KEYLESS:</b>	NEE
<b>FREQUENTIE</b>	433 MHZ
<b>BATTERIJ:</b>	CR2032
<b>ORIGINELE NUMMER:</b>	
<b>NOODSLEUTEL:</b>	NEE
<b>PROFIEL:</b>	VX5 - HU100
<b>MODEL:</b>	2 KNOPPEN
<b>MODELLEN:</b>	
VECTRA C	

#### OPEL ASTRA J



OPE-R003

#### EIGENSCHAPPEN:

<b>TRANSPONDER:</b>	ID46 PCF7941
<b>KEYLESS:</b>	NEE
<b>FREQUENTIE</b>	433 MHZ
<b>BATTERIJ:</b>	CR2032
<b>ORIGINELE NUMMER:</b>	
<b>NOODSLEUTEL:</b>	NEE
<b>PROFIEL:</b>	VX5 - HU100
<b>MODEL:</b>	2 KNOPPEN
<b>MODELLEN:</b>	
ASTRA J	

## AUTOSLEUTELS EN AFSTANDBEDIENINGEN

AFBEELDING:	ART. NR.:	OMSCHRIJVING:
-------------	-----------	---------------

### OPEL

#### OPEL ASTRA J / INSIGNIA



OPE-R004

#### EIGENSCHAPPEN:

<b>TRANSPONDER:</b>	ID46 PCF7941 HITAG2
<b>KEYLESS:</b>	NEE
<b>FREQUENTIE</b>	433 MHZ
<b>BATTERIJ:</b>	CR2032
<b>ORIGINELE NUMMER:</b>	
<b>NOODSLEUTEL:</b>	NEE
<b>PROFIEL:</b>	VX5 - HU100
<b>MODEL:</b>	3 KNOPPEN
<b>MODELLEN:</b>	
	ASTRA J (2010-2015)
	INSIGNIA (2010-2015)

#### OPEL ASTRA H



OPE-R005

#### EIGENSCHAPPEN:

<b>TRANSPONDER:</b>	ID46 PCF7941
<b>KEYLESS:</b>	NEE
<b>FREQUENTIE</b>	433 MHZ
<b>BATTERIJ:</b>	CR2032
<b>ORIGINELE NUMMER:</b>	
<b>NOODSLEUTEL:</b>	NEE
<b>PROFIEL:</b>	VX5 - HU100
<b>MODEL:</b>	2 KNOPPEN
<b>MODELLEN:</b>	
	ASTRA H (2004-2009)
	ZAFIRA B (2005-2014)

## AUTOSLEUTELS EN AFSTANDSBEDIENINGEN

AFBEELDING:	ART. NR.:	OMSCHRIJVING:
-------------	-----------	---------------

### OPEL

#### OPEL CORSA D



OPE-R007

#### EIGENSCHAPPEN:

<b>TRANSPONDER:</b>	ID46 PCF7946 HITAG2
<b>KEYLESS:</b>	NEE
<b>FREQUENTIE</b>	433 MHZ
<b>BATTERIJ:</b>	CR2032
<b>ORIGINELE NUMMER:</b>	
<b>NOODSLEUTEL:</b>	NEE
<b>PROFIEL:</b>	VX5 - HU100
<b>MODEL:</b>	2 KNOPPEN
<b>MODELLEN:</b>	
	CORSA D (2009-2012)

#### OPEL VECTRA C



OPE-R009

#### EIGENSCHAPPEN:

<b>TRANSPONDER:</b>	ID46 PCF7946
<b>KEYLESS:</b>	NEE
<b>FREQUENTIE</b>	433 MHZ
<b>BATTERIJ:</b>	CR2032
<b>ORIGINELE NUMMER:</b>	
<b>NOODSLEUTEL:</b>	NEE
<b>PROFIEL:</b>	VX5 - HU100
<b>MODEL:</b>	2 KNOPPEN
<b>MODELLEN:</b>	
	VECTRA C (2002-2008)
	SIGNUM (2003-2007)

## AUTOSLEUTELS EN AFSTANDSBEDIENINGEN

AFBEELDING:

ART. NR.:

OMSCHRIJVING:

### OPEL

OPEL



OPE-R010

#### EIGENSCHAPPEN:

<b>TRANSPONDER:</b>	GEEN
<b>KEYLESS:</b>	NEE
<b>FREQUENTIE</b>	433 MHZ
<b>BATTERIJ:</b>	CR2032
<b>ORIGINELE NUMMER:</b>	
<b>NOODSLEUTEL:</b>	NEE
<b>PROFIEL:</b>	
<b>MODEL:</b>	2 KNOPPEN
<b>MODELLEN:</b>	
CORSA C (2001-2007)	MERIVA (2003-2006)
COMBO (2002-2009)	TIGRA (2004-2006)

OPEL MERIVA / CORSA D



OPE-R011

#### EIGENSCHAPPEN:

<b>TRANSPONDER:</b>	ID46 PCF7941E (PCF7937)
	HITAG2
<b>KEYLESS:</b>	NEE
<b>FREQUENTIE</b>	433 MHZ
<b>BATTERIJ:</b>	CR2032
<b>ORIGINELE NUMMER:</b>	
<b>NOODSLEUTEL:</b>	NEE
<b>PROFIEL:</b>	VX5 - HU100
<b>MODEL:</b>	2 KNOPPEN
<b>MODELLEN:</b>	
MERIVA (2007-2011)	CORSA D (2008-2011)

OPEL ASTRA K



OPE-R012

#### EIGENSCHAPPEN:

<b>TRANSPONDER:</b>	PCF7961 HITAG2
<b>KEYLESS:</b>	NEE
<b>FREQUENTIE</b>	433 MHZ
<b>BATTERIJ:</b>	CR2032
<b>ORIGINELE NUMMER:</b>	
<b>NOODSLEUTEL:</b>	NEE
<b>PROFIEL:</b>	VX5 - H100
<b>MODEL:</b>	2 KNOPPEN
<b>MODELLEN:</b>	
ASTRA K (2015-2017)	

## AUTOSLEUTELS EN AFSTANDSBEDIENINGEN

AFBEELDING:	ART. NR.:	OMSCHRIJVING:
-------------	-----------	---------------

### OPEL

#### OPEL ASTRA K KEYLESS



OPE-R013

#### EIGENSCHAPPEN:

TRANSPONDER:	NCF2951E
KEYLESS:	JA
FREQUENTIE	433 MHZ
BATTERIJ:	CR2032
ORIGINELE NUMMER:	
NOODSLEUTEL:	NEE
PROFIEL:	
MODEL:	3 KNOPPEN
MODELLEN:	
ASTRA K (2018)	

#### OPEL ADAM



OPE-R014

#### EIGENSCHAPPEN:

TRANSPONDER:	PCF7937
KEYLESS:	NEE
FREQUENTIE	433 MHZ
BATTERIJ:	CR2032
ORIGINELE NUMMER:	
NOODSLEUTEL:	NEE
PROFIEL:	VX5 - HU100
MODEL:	3 KNOPPEN
MODELLEN:	
ADAM (2013+)	

#### OPEL



OPE-R015

#### EIGENSCHAPPEN:

TRANSPONDER:	PCF7952E HITAG 2 ID46
KEYLESS:	JA
FREQUENTIE	433 MHZ
BATTERIJ:	CR2032
ORIGINELE NUMMER:	
NOODSLEUTEL:	NEE
PROFIEL:	VX5 - HU100
MODEL:	3 KNOPPEN
MODELLEN:	
ASTRA J 2013+	CRUZE 2013+
INSIGNIA 2013+	AVEO 2013+

## AUTOSLEUTELS EN AFSTANDSBEDIENINGEN

AFBEELDING:	ART. NR.:	OMSCHRIJVING:
-------------	-----------	---------------

### OPEL

OPEL



OPE-R016

#### EIGENSCHAPPEN:

<b>TRANSPONDER:</b>	ID46 PCF7941
<b>KEYLESS:</b>	NEE
<b>FREQUENTIE</b>	433 MHZ
<b>BATTERIJ:</b>	CR2032
<b>ORIGINELE NUMMER:</b>	
<b>NOODSLEUTEL:</b>	NEE
<b>PROFIEL:</b>	VX5 - HU100
<b>MODEL:</b>	2 KNOPPEN
<b>MODELLEN:</b>	
	ASTRA J (2010-2015)

OPEL CORSA



OPE-R017

#### EIGENSCHAPPEN:

<b>TRANSPONDER:</b>	PCF7941A HITAG 2 ID46
<b>KEYLESS:</b>	NEE
<b>FREQUENTIE</b>	433 MHZ
<b>BATTERIJ:</b>	CR2032
<b>ORIGINELE NUMMER:</b>	
<b>NOODSLEUTEL:</b>	NEE
<b>PROFIEL:</b>	VX5 - HU100
<b>MODEL:</b>	2 KNOPPEN
<b>MODELLEN:</b>	
	CORSA (2006-2015)

OPEL



REN-R008

#### EIGENSCHAPPEN:

<b>TRANSPONDER:</b>	ID46 PCF7946
<b>KEYLESS:</b>	NEE
<b>FREQUENTIE</b>	433 MHZ
<b>BATTERIJ:</b>	CR2032
<b>ORIGINELE NUMMER:</b>	
<b>NOODSLEUTEL:</b>	NEE
<b>PROFIEL:</b>	PG33 - VA2
<b>MODEL:</b>	2 KNOPPEN
<b>MODELLEN:</b>	
	VIVARO (2002-2009)
	MOVANO (2004-2009)

## AUTOSLEUTELS EN AFSTANDBEDIENINGEN

AFBEELDING:	ART. NR.:	OMSCHRIJVING:
-------------	-----------	---------------

### OPEL

OPEL



#### EIGENSCHAPPEN:

REN-R021

<b>TRANSPONDER:</b>	ID46 PCF7946
<b>KEYLESS:</b>	NEE
<b>FREQUENTIE</b>	433 MHZ
<b>BATTERIJ:</b>	CR2032
<b>ORIGINELE NUMMER:</b>	
<b>NOODSLEUTEL:</b>	NEE
<b>PROFIEL:</b>	PG33 - VA2
<b>MODEL:</b>	2 KNOPPEN
<b>MODELLEN:</b>	
	VIVARO (2008+)

## AUTOSLEUTELS EN AFSTANDSBEDIENINGEN

AFBEELDING:

ART. NR.:

OMSCHRIJVING:

### PSA GROUP (CITROËN-PEUGEOT)

CITROËN DS5

EIGENSCHAPPEN:



CIT-R001

<b>TRANSPONDER:</b>	ID46 PCF7945
<b>KEYLESS:</b>	JA
<b>FREQUENTIE</b>	433 MHZ
<b>BATTERIJ:</b>	CR2032
<b>ORIGINELE NUMMER:</b>	2011DJ1873 (DS5/C4)
<b>NOODSLEUTEL:</b>	JA
<b>PROFIEL:</b>	PG33 - VA2
<b>MODEL:</b>	3 KNOPPEN
<b>MODELLEN:</b>	
C4 (2010-2016)	C4 PICASSO (2013-2016)
DS5 (2011-2016)	C4 GRAN PICASSO ('13-'16)

CITROËN C4

EIGENSCHAPPEN:



CIT-R002

<b>TRANSPONDER:</b>	ID46 PCF7941
<b>KEYLESS:</b>	NEE
<b>FREQUENTIE</b>	433 MHZ
<b>BATTERIJ:</b>	CR1620
<b>ORIGINELE NUMMER:</b>	
<b>NOODSLEUTEL:</b>	NEE
<b>PROFIEL:</b>	PG33 - VA2
<b>MODEL:</b>	3 KNOPPEN
<b>MODELLEN:</b>	C5 (-2010) C4 GRAND PICASSO SMART CARD (-2010)

CITROËN / PEUGEOT

EIGENSCHAPPEN:



CIT-R003

<b>TRANSPONDER:</b>	PCF7961
<b>KEYLESS:</b>	NEE
<b>FREQUENTIE</b>	433 MHZ
<b>BATTERIJ:</b>	CR1620
<b>ORIGINELE NUMMER:</b>	
<b>NOODSLEUTEL:</b>	NEE
<b>PROFIEL:</b>	PG33 - VA2
<b>MODEL:</b>	2 KNOPPEN
<b>MODELLEN:</b>	
<b>CITROËN:</b>	<b>PEUGEOT:</b>
C3 ( 2005-2010)	207/307/308/PARTNER ('10+)
C3/BERLINGO (2010+)	308 (7.2008-3.2010)
207/307/308 (2005-2010)	3008/5008/PARTNER ('09-'16)



## AUTOSLEUTELS EN AFSTANDSBEDIENINGEN

AFBEELDING:	ART. NR.:	OMSCHRIJVING:
-------------	-----------	---------------

### PSA GROUP (CITROËN-PEUGEOT)

#### CITROËN / PEUGEOT



PSA-R001

#### EIGENSCHAPPEN:

TRANSPONDER:	PCF7941
KEYLESS:	NEE
FREQUENTIE	433 MHZ
BATTERIJ:	CR1620
ORIGINELE NUMMER:	
NOODSLEUTEL:	NEE
PROFIEL:	PG33 - VA2
MODEL:	3 KNOPPEN
MODELLEN:	
PSA (CITROËN-PEUGEOT (2006+))	

#### PEUGEOT



PEU-R001

#### EIGENSCHAPPEN:

TRANSPONDER:	ID46 PCF7945
KEYLESS:	JA
FREQUENTIE	433 MHZ
BATTERIJ:	CR2032
ORIGINELE NUMMER:	
NOODSLEUTEL:	JA
PROFIEL:	VX5 - HU100
MODEL:	3 KNOPPEN
MODELLEN:	
308 (2013-5.2015)      508 (2013-5.2015)	

#### PEUGEOT 307



PEU-R002

#### EIGENSCHAPPEN:

TRANSPONDER:	PCF7941
KEYLESS:	NEE
FREQUENTIE	433 MHZ
BATTERIJ:	CR1620
ORIGINELE NUMMER:	
NOODSLEUTEL:	NEE
PROFIEL:	PG33 - VA2
MODEL:	2 KNOPPEN
MODELLEN:	
307 (-2011)	

## AUTOSLEUTELS EN AFSTANDSBEDIENINGEN

AFBEELDING:

ART. NR.:

OMSCHRIJVING:

### PSA GROUP (CITROËN-PEUGEOT)

#### CITROËN / PEUGEOT



PEU-R003

#### EIGENSCHAPPEN:

<b>TRANSPONDER:</b>	ID46 PCF7941
<b>KEYLESS:</b>	NEE
<b>FREQUENTIE</b>	433 MHZ
<b>BATTERIJ:</b>	CR1620
<b>ORIGINELE NUMMER:</b>	
<b>NOODSLEUTEL:</b>	NEE
<b>PROFIEL:</b>	PG33 - VA2
<b>MODEL:</b>	3 KNOPPEN
<b>MODELLEN:</b>	
206 (2006+)	408 (2006+)
207 (2006+)	C2 (2006+)
307 (2006+)	C4 (2006+)

#### CITROËN / PEUGEOT KEYLESS



PEU-R004

#### EIGENSCHAPPEN:

<b>TRANSPONDER:</b>	ID46 PCF7945/7953
<b>KEYLESS:</b>	JA
<b>FREQUENTIE</b>	433 MHZ
<b>BATTERIJ:</b>	CR1620
<b>ORIGINELE NUMMER:</b>	2011DJ1873
<b>NOODSLEUTEL:</b>	NEE
<b>PROFIEL:</b>	VX5 - HU100
<b>MODEL:</b>	3 KNOPPEN
<b>MODELLEN:</b>	<b>CITROEN:</b>
<b>PEUGEOT:</b>	C4 (2010-2016)
308 (2014-5.2016)	C4 (GRAND) PICASSO ('13-'16)
508 (2010-5.2016)	DS5 (2011-2016)

#### PEUGEOT 307



PEU-R005

#### EIGENSCHAPPEN:

<b>TRANSPONDER:</b>	ID46
<b>KEYLESS:</b>	NEE
<b>FREQUENTIE</b>	433 MHZ
<b>BATTERIJ:</b>	CR1620
<b>ORIGINELE NUMMER:</b>	
<b>NOODSLEUTEL:</b>	NEE
<b>PROFIEL:</b>	PG33 - VA2
<b>MODEL:</b>	3 KNOPPEN
<b>MODELLEN:</b>	
307 (2011+)	

## AUTOSLEUTELS EN AFSTANDSBEDIENINGEN

AFBEELDING:	ART. NR.:	OMSCHRIJVING:
-------------	-----------	---------------

### PSA GROUP (CITROËN-PEUGEOT)

#### PEUGEOT 407 OUD TYPE



PEU-R006

#### EIGENSCHAPPEN:

TRANSPONDER:	PCF7941
KEYLESS:	NEE
FREQUENTIE	433 MHZ
BATTERIJ:	CR1620
ORIGINELE NUMMER:	
NOODSLEUTEL:	NEE
PROFIEL:	PG33 - VA2
MODEL:	3 KNOPPEN
MODELLEN:	
PEUGEOT 406 OUD TYPE (2006+)	

#### PEUGEOT



PEU-R007

#### EIGENSCHAPPEN:

TRANSPONDER:	PCF7941
KEYLESS:	NEE
FREQUENTIE	433 MHZ
BATTERIJ:	CR1620
ORIGINELE NUMMER:	
NOODSLEUTEL:	NEE
PROFIEL:	PG33 - VA2
MODEL:	2 KNOPPEN
MODELLEN:	
307 (+2011)	

#### PEUGEOT



PEU-R008

#### EIGENSCHAPPEN:

TRANSPONDER:	PCF7941 HITAG2
KEYLESS:	NEE
FREQUENTIE	433 MHZ
BATTERIJ:	CR2032
ORIGINELE NUMMER:	
NOODSLEUTEL:	NO
PROFIEL:	PG33 - VA2
MODEL:	3 KNOPPEN
MODELLEN:	
PEUGEOT:	
208 (2011-2016)	308 (2011-2016)

## AUTOSLEUTELS EN AFSTANDSBEDIENINGEN

AFBEELDING:

ART. NR.:

OMSCHRIJVING:

### PSA GROUP (CITROËN-PEUGEOT)

#### CITROËN / PEUGEOT KEYLESS



PEU-R009

#### EIGENSCHAPPEN:

TRANSPONDER:	7953M HITAG AES
KEYLESS:	JA
FREQUENTIE	433 MHZ
BATTERIJ:	CR2032
ORIGINELE NUMMER:	
NOODSLEUTEL:	NEE
PROFIEL:	
MODEL:	3 KNOPPEN
MODELLEN:	
208 2017+	C4 2017+
308 2017+	C4 CACTUS 2017+

#### PEUGEOT



PEU-R010

#### EIGENSCHAPPEN:

TRANSPONDER:	ID46 PCF7961
KEYLESS:	NEE
FREQUENTIE	433 MHZ
BATTERIJ:	CR2016
ORIGINELE NUMMER:	
NOODSLEUTEL:	NEE
PROFIEL:	PG33 - VA2
MODEL:	2 KNOPPEN
MODELLEN:	
206	

#### PEUGEOT



PEU-R011

#### EIGENSCHAPPEN:

TRANSPONDER:	ID46 PCF7961*
KEYLESS:	NEE
FREQUENTIE	433 MHZ
BATTERIJ:	CR2016
ORIGINELE NUMMER:	
NOODSLEUTEL:	NEE
PROFIEL:	PG33 - VA2
MODEL:	2 KNOPPEN
MODELLEN:	
307	
* MET GEINTEGREERDE TRANSPONDER	

## AUTOSLEUTELS EN AFSTANDBEDIENINGEN

AFBEELDING:	ART. NR.:	OMSCHRIJVING:
-------------	-----------	---------------

### PSA GROUP (CITROËN-PEUGEOT)

#### CITROËN / PEUGEOT



PEU-R012

#### EIGENSCHAPPEN:

<b>TRANSPONDER:</b>	NCF2960M HITAG AES
<b>KEYLESS:</b>	NEE
<b>FREQUENTIE</b>	433 MHZ
<b>BATTERIJ:</b>	CR2032
<b>ORIGINELE NUMMER:</b>	
<b>NOODSLEUTEL:</b>	NEE
<b>PROFIEL:</b>	PG33 - VA2
<b>MODEL:</b>	3 KNOPPEN
<b>MODELLEN:</b>	
208 2017+	C3 2017+
308 2017+	C3 AIRCROSS 2017+

#### CITROËN / PEUGEOT



FIA-R001

#### EIGENSCHAPPEN:

<b>TRANSPONDER:</b>	DELPHI PCF7946
<b>KEYLESS:</b>	NEE
<b>FREQUENTIE</b>	433 MHZ
<b>BATTERIJ:</b>	CR2032
<b>ORIGINELE NUMMER:</b>	
<b>NOODSLEUTEL:</b>	NEE
<b>PROFIEL:</b>	FT22 - SIP22
<b>MODEL:</b>	3 KNOPPEN
<b>MODELLEN:</b>	
<b>CITROËN:</b>	<b>PEUGEOT:</b>
NEMO (2007-2016)	BIPPER (2007-2016)

#### CITROËN / PEUGEOT



FIA-R002

#### EIGENSCHAPPEN:

<b>TRANSPONDER:</b>	MARELLI PCF7946
<b>KEYLESS:</b>	NEE
<b>FREQUENTIE</b>	433 MHZ
<b>BATTERIJ:</b>	CR2032
<b>ORIGINELE NUMMER:</b>	
<b>NOODSLEUTEL:</b>	NEE
<b>PROFIEL:</b>	FT22 - SIP22
<b>MODEL:</b>	3 KNOPPEN
<b>MODELLEN:</b>	<b>CITROËN:</b>
<b>PEUGEOT:</b>	JUMPER (2010-2016)
BOXER (2010-2016)	RELAY (2010-2016)

## AUTOSLEUTELS EN AFSTANDBEDIENINGEN

AFBEELDING:	ART. NR.:	OMSCHRIJVING:
-------------	-----------	---------------

### RENAULT KEYLESS

#### RENAULT KEYLESS



REN-R001

#### EIGENSCHAPPEN:

<b>TRANSPONDER:</b>	PCF7953
<b>KEYLESS:</b>	JA
<b>FREQUENTIE</b>	433 MHZ
<b>BATTERIJ:</b>	CR2032
<b>ORIGINELE NUMMER:</b>	285971998R
<b>NOODSLEUTEL:</b>	JA
<b>PROFIEL:</b>	PG33 - VA2
<b>MODEL:</b>	4 KNOPPEN
<b>MODELLEN:</b>	
CLIO 4 (2012-CR2016)	SYMBOL (2013-CR2016)
CAPTUR (2013-CR2016)	

#### RENAULT TRAFIC / KANGOO



REN-R002

#### EIGENSCHAPPEN:

<b>TRANSPONDER:</b>	ID46 PCF7946
<b>KEYLESS:</b>	NEE
<b>FREQUENTIE</b>	433 MHZ
<b>BATTERIJ:</b>	CR1220
<b>ORIGINELE NUMMER:</b>	
<b>NOODSLEUTEL:</b>	NEE
<b>PROFIEL:</b>	VE20 - VAC102
<b>MODEL:</b>	2 KNOPPEN
<b>MODELLEN:</b>	
TRAFIC (2014+)	
KANGOO (2014+)	

#### RENAULT KEYLESS



REN-R003

#### EIGENSCHAPPEN:

<b>TRANSPONDER:</b>	ID46 PCF7947 HITAG2
<b>KEYLESS:</b>	JA
<b>FREQUENTIE</b>	433 MHZ
<b>BATTERIJ:</b>	CR1620
<b>ORIGINELE NUMMER:</b>	
<b>NOODSLEUTEL:</b>	JA
<b>PROFIEL:</b>	PG33 - VA2
<b>MODEL:</b>	2 KNOPPEN
<b>MODELLEN:</b>	
LAGUNA (2001-2008)	VELSATIS (2002-2009)
SPACE (12.2002-2006)	

## AUTOSLEUTELS EN AFSTANDSBEDIENINGEN

AFBEELDING:	ART. NR.:	OMSCHRIJVING:
-------------	-----------	---------------

### RENAULT

#### RENAULT CLIO2 / KANGOO



REN-R004

#### EIGENSCHAPPEN:

TRANSPONDER:	ID46 PCF7947
KEYLESS:	NEE
FREQUENTIE	433 MHZ
BATTERIJ:	CR1220
ORIGINELE NUMMER:	
NOODSLEUTEL:	NEE
PROFIEL:	VE20 - VAC102
MODEL:	
MODELLEN:	2 KNOPPEN
CLIO2 (1998-2009)	
KANGOO (2002-2008)	

#### RENAULT CLIO4



REN-R005

#### EIGENSCHAPPEN:

TRANSPONDER:	ID47 PCF7952
KEYLESS:	NEE
FREQUENTIE	433 MHZ
BATTERIJ:	CR2025
ORIGINELE NUMMER:	
NOODSLEUTEL:	JA
PROFIEL:	PG33 - VA2
MODEL:	4 KNOPPEN
MODELLEN:	
CLIO4 (-2018)	

#### RENAULT MEGANE / SCENIC



REN-R006

#### EIGENSCHAPPEN:

TRANSPONDER:	ID46 PCF7947 PH.CR.2
KEYLESS:	NEE
FREQUENTIE	433 MHZ
BATTERIJ:	CR2025
ORIGINELE NUMMER:	
NOODSLEUTEL:	JA
PROFIEL:	PG33 - VA2
MODEL:	3 KNOPPEN
MODELLEN:	
MEGANE (2003-2011)	
SCENIC (2003-2011)	

## AUTOSLEUTELS EN AFSTANDSBEDIENINGEN

AFBEELDING:	ART. NR.:	OMSCHRIJVING:
-------------	-----------	---------------

### RENAULT

#### RENAULT CLIO3



#### EIGENSCHAPPEN:

<b>TRANSPONDER:</b>	ID47 PCF7961 ASK
<b>KEYLESS:</b>	NEE
<b>FREQUENTIE</b>	433 MHZ
<b>BATTERIJ:</b>	CR2032
<b>ORIGINELE NUMMER:</b>	
<b>NOODSLEUTEL:</b>	NEE
<b>PROFIEL:</b>	PG33 - VA2
<b>MODEL:</b>	2 KNOPPEN
<b>MODELLEN:</b>	
CLIO3 (2006-2012)	

#### RENAULT



#### EIGENSCHAPPEN:

<b>TRANSPONDER:</b>	ID46 PCF7946
<b>KEYLESS:</b>	NEE
<b>FREQUENTIE</b>	433 MHZ
<b>BATTERIJ:</b>	CR2032
<b>ORIGINELE NUMMER:</b>	
<b>NOODSLEUTEL:</b>	NEE
<b>PROFIEL:</b>	PG33 - VA2
<b>MODEL:</b>	2 KNOPPEN
<b>MODELLEN:</b>	
KANGOO (2003-2010) TRAFIC (2004-2009)	
MASTER (2005-2010)	

#### RENAULT



#### EIGENSCHAPPEN:

<b>TRANSPONDER:</b>	ID47 PCF7939 PH.CR.3
	HITAG/AES
<b>FREQUENTIE</b>	433 MHZ
<b>BATTERIJ:</b>	CR2016
<b>ORIGINELE NUMMER:</b>	
<b>NOODSLEUTEL:</b>	NEE
<b>PROFIEL:</b>	VE20 - VAC102
<b>MODEL:</b>	3 KNOPPEN
<b>MODELLEN:</b>	CLIO 3 (2006-2010)
KANGOO (2010-2016) TWINGO (2007-2010)	
MASTER (2010-2016) KANGOO 2006-2009)	
MODUS (2004-2012) TRAFIC (2007-2009)	



## AUTOSLEUTELS EN AFSTANDBEDIENINGEN

AFBEELDING:	ART. NR.:	OMSCHRIJVING:
-------------	-----------	---------------

### RENAULT

#### RENAULT



#### EIGENSCHAPPEN:

REN-R010

<b>TRANSPONDER:</b>	ID46 PCF7946
<b>KEYLESS:</b>	NEE
<b>FREQUENTIE</b>	433 MHZ
<b>BATTERIJ:</b>	CR2016
<b>ORIGINELE NUMMER:</b>	
<b>NOODSLEUTEL:</b>	NEE
<b>PROFIEL:</b>	VE20 - VAC102
<b>MODEL:</b>	3 KNOPPEN
<b>MODELLEN:</b>	
KANGOO (2007-2014)	TRAFIC (-2010)
MASTER (-2010)	

#### RENAULT



#### EIGENSCHAPPEN:

REN-R011

<b>TRANSPONDER:</b>	ID46 PCF7947
<b>KEYLESS:</b>	NEE
<b>FREQUENTIE</b>	433 MHZ
<b>BATTERIJ:</b>	CR2016
<b>ORIGINELE NUMMER:</b>	
<b>NOODSLEUTEL:</b>	NEE
<b>PROFIEL:</b>	VE20 - VAC102
<b>MODEL:</b>	3 KNOPPEN
<b>MODELLEN:</b>	CLIO3 (2006-2010)
KANGOO (2010-2014)	MODUS (-2006)
MASTER (2010-2015)	TWINGO (-2007)

#### RENAULT



#### EIGENSCHAPPEN:

REN-R012

<b>TRANSPONDER:</b>	ID46 PCF7961
<b>KEYLESS:</b>	NEE
<b>FREQUENTIE</b>	433 MHZ
<b>BATTERIJ:</b>	CR2032
<b>ORIGINELE NUMMER:</b>	
<b>NOODSLEUTEL:</b>	NEE
<b>PROFIEL:</b>	VE20 - VAC102
<b>MODEL:</b>	3 KNOPPEN
<b>MODELLEN:</b>	
FLUENCE (2009-2015)	
MEGANE 3 (-2009)	

## AUTOSLEUTELS EN AFSTANDSBEDIENINGEN

AFBEELDING:	ART. NR.:	OMSCHRIJVING:
-------------	-----------	---------------

### RENAULT

#### RENAULT KEYLESS



RENAULT

REN-R013

#### EIGENSCHAPPEN:

TRANSPONDER:	ID46 PCF7952
KEYLESS:	JA
FREQUENTIE	433 MHZ
BATTERIJ:	CR2032
ORIGINELE NUMMER:	
NOODSLEUTEL:	JA
PROFIEL:	PG33 - VA2
MODEL:	4 KNOPPEN
MODELLEN:	
LAGUNA3 (2007-2012)	FLUENCE (2012-2016)
MEGANE3 (2009-2013)	GRAND SCENIC ( '09-'12)
SCENIC3 (2009-2013)	

#### EIGENSCHAPPEN:

TRANSPONDER:	ID46 PCF7961
KEYLESS:	NEE
FREQUENTIE	433 MHZ
BATTERIJ:	CR2032
ORIGINELE NUMMER:	
NOODSLEUTEL:	JA
PROFIEL:	PG33 - VA2
MODEL:	4 KNOPPEN
MODELLEN:	
LAGUNA3 (2007-2012)	FLUENCE (2012-2016)
MEGANE3 (2009-2013)	GRAND SCENIC ( '09-'12)
SCENIC3 (2009-2013)	

REN-R014



RENAULT

#### EIGENSCHAPPEN:

TRANSPONDER:	ID47 PCF7939 PH.CR.3 HITAG AES
KEYLESS:	NEE
FREQUENTIE	433 MHZ
BATTERIJ:	CR2016
NOODSLEUTEL:	NEE
PROFIEL:	VE20 - VAC102
MODEL:	2 KNOPPEN
MODELLEN:	
SYMBOL (-2012)	CLIO 4 (2013+)
TRAFIC (-2015)	

REN-R015



## AUTOSLEUTELS EN AFSTANDSBEDIENINGEN

AFBEELDING:	ART. NR.:	OMSCHRIJVING:
-------------	-----------	---------------

### RENAULT

#### RENAULT



REN-R016

#### EIGENSCHAPPEN:

TRANSPONDER:	ID46 PCF7946
KEYLESS:	NEE
FREQUENTIE	433 MHZ
BATTERIJ:	CR2016
ORIGINELE NUMMER:	
NOODSLEUTEL:	NEE
PROFIEL:	VE20 - VAC102
MODEL:	2 KNOPPEN
MODELLEN:	
KANGOO (2007-2014)	TRAFIC (-2010)
MASTER (-2010)	

#### RENAULT



REN-R017

#### EIGENSCHAPPEN:

TRANSPONDER:	ID46 PCF7947
KEYLESS:	NEE
FREQUENTIE	433 MHZ
BATTERIJ:	CR2016
ORIGINELE NUMMER:	
NOODSLEUTEL:	NEE
PROFIEL:	VE20 - VAC102
MODEL:	2 KNOPPEN
MODELLEN:	
CLIO 3 (2006-2010)	MASTER (2010-2015)
KANGOO (2010-2014)	

#### RENAULT



REN-R018

#### EIGENSCHAPPEN:

TRANSPONDER:	PCF7939 HITAG AES (PCF7961M)
KEYLESS:	NEE
FREQUENTIE	433 MHZ
BATTERIJ:	CR2016
ORIGINELE NUMMER:	
NOODSLEUTEL:	NEE
PROFIEL:	VE20 - VAC102
MODEL:	2 KNOPPEN
MODELLEN:	
SYMBOL (2012-2016)	TRAFIC (-2015)

## AUTOSLEUTELS EN AFSTANDSBEDIENINGEN

AFBEELDING:	ART. NR.:	OMSCHRIJVING:
-------------	-----------	---------------

### RENAULT

#### RENAULT



#### EIGENSCHAPPEN:

<b>TRANSPONDER:</b>	PCF7961M
<b>KEYLESS:</b>	NEE
<b>FREQUENTIE</b>	433 MHZ
<b>BATTERIJ:</b>	CR2016
<b>REN-R019</b>	<b>ORIGINELE NUMMER:</b>
	<b>NOODSLEUTEL:</b> NEE
	<b>PROFIEL:</b>
	<b>MODEL:</b> 2 KNOPPEN
	<b>MODELLEN:</b>
	SYMBOL (2012-CR2016)
	TRAFIC (-2015)

#### RENAULT



#### EIGENSCHAPPEN:

<b>TRANSPONDER:</b>	PCF7939 HITAG AES (PCF7961M)
<b>KEYLESS:</b>	NEE
<b>FREQUENTIE</b>	433 MHZ
<b>REN-R020</b>	<b>BATTERIJ:</b> CR2016
	<b>NOODSLEUTEL:</b> NEE
	<b>PROFIEL:</b> PG33 - VA2
	<b>MODEL:</b> 3 KNOPPEN
	<b>MODELLEN:</b>
	MEGANE4 (2016+) KADJAR (-2015)
	CAPTUR (-2013) SYMBOL (-2012)

#### RENAULT



#### EIGENSCHAPPEN:

<b>TRANSPONDER:</b>	ID46 PCF7947
<b>KEYLESS:</b>	NEE
<b>FREQUENTIE</b>	433 MHZ
<b>BATTERIJ:</b>	CR2032
<b>REN-R021</b>	<b>ORIGINELE NUMMER:</b>
	<b>NOODSLEUTEL:</b> NEE
	<b>PROFIEL:</b> PG33 - VA2
	<b>MODEL:</b> 3 KNOPPEN
	<b>MODELLEN:</b>
	CLIO 3 (2006-2010)
	KANGOO (2010-2014) MODUS (-2006)
	MASTER (2010-2015) TWINGO (-2007)

## AUTOSLEUTELS EN AFSTANDSBEDIENINGEN

AFBEELDING:	ART. NR.:	OMSCHRIJVING:
-------------	-----------	---------------

### RENAULT

#### RENAULT



REN-R022

#### EIGENSCHAPPEN:

<b>TRANSPONDER:</b>	ID46 (PH20) PCF7946
	PH.CR2 / HITAG2
<b>KEYLESS:</b>	NEE
<b>FREQUENTIE</b>	433 MHZ
<b>BATTERIJ:</b>	CR1220
<b>ORIGINELE NUMMER:</b>	
<b>NOODSLEUTEL:</b>	NEE
<b>PROFIEL:</b>	RN30 - NE72
<b>MODEL:</b>	1 KNOP
<b>MODELLEN:</b>	
	CLIO (2001-2008)
	KANGOO (2002-2004)

#### RENAULT KEYLESS



REN-R023

#### EIGENSCHAPPEN:

<b>TRANSPONDER:</b>	ID46 PCF7953
<b>KEYLESS:</b>	JA
<b>FREQUENTIE</b>	433 MHZ
<b>BATTERIJ:</b>	CR2032
<b>ORIGINELE NUMMER:</b>	
<b>NOODSLEUTEL:</b>	JA
<b>PROFIEL:</b>	
<b>MODEL:</b>	4 KNOPPEN
<b>MODELLEN:</b>	
	LAGUNA (2008-2012) SCENIC (2009-2015)
	MEGANE (2009-2015) FLUENCE (2012-2016)

## AUTOSLEUTELS EN AFSTANDSBEDIENINGEN

AFBEELDING:	ART. NR.:	OMSCHRIJVING:
-------------	-----------	---------------

### SEAT

#### VOLKSWAGEN UDS

#### EIGENSCHAPPEN:



VAG GROUP

VAG-R001

<b>TRANSPONDER:</b>	ID48 CANBUS (EXCLUSIEF)
<b>KEYLESS:</b>	NEE
<b>FREQUENTIE</b>	433 MHZ
<b>BATTERIJ:</b>	CR2032
<b>ORIGINELE NUMMER:</b>	7N583202H, 5K0837202AD 3T0959753L, 7E0837202BD 7E0837202AF
<b>NOODSLEUTEL:</b>	NEE
<b>PROFIEL:</b>	V66 - HU66
<b>MODEL:</b>	2 KNOPPEN
<b>MODELLEN:</b>	ALTEA (2010-2014) IBIZA (2010-2014)

#### EIGENSCHAPPEN:



VAG GROUP

VAG-R002

<b>TRANSPONDER:</b>	NEE
<b>KEYLESS:</b>	NEE
<b>FREQUENTIE</b>	433 MHZ
<b>BATTERIJ:</b>	CR2032
<b>ORIGINELE NUMMER:</b>	1J0959753AG, 1J0959753CT
<b>NOODSLEUTEL:</b>	NEE
<b>PROFIEL:</b>	
<b>MODEL:</b>	2 KNOPPEN
<b>MODELLEN:</b>	LEON (2001-2005) IBIZA (2003-2008) CORDOBA (2003-2008) TOLEDO (2001-2004)

#### EIGENSCHAPPEN:



VAG-R003

<b>TRANSPONDER:</b>	NEE
<b>KEYLESS:</b>	NEE
<b>FREQUENTIE</b>	433 MHZ
<b>BATTERIJ:</b>	CR2032
<b>ORIGINELE NUMMER:</b>	1J0959753DA
<b>NOODSLEUTEL:</b>	NEE
<b>PROFIEL:</b>	
<b>MODEL:</b>	3 KNOPPEN
<b>MODELLEN:</b>	LEON

## AUTOSLEUTELS EN AFSTANDSBEDIENINGEN

AFBEELDING:	ART. NR.:	OMSCHRIJVING:
-------------	-----------	---------------

### SKODA

#### VOLKSWAGEN UDS



VAG-R001

#### EIGENSCHAPPEN:

<b>TRANSPONDER:</b>	ID48 CANBUS (EXCLUSIEF)
<b>KEYLESS:</b>	NEE
<b>FREQUENTIE</b>	433 MHZ
<b>BATTERIJ:</b>	CR2032
<b>ORIGINELE NUMMER:</b>	7N583202H, 5K0837202AD
	3T0959753L, 7E0837202BD
	7E0837202AF
<b>PROFIEL:</b>	V66 - HU66
<b>MODEL:</b>	2 KNOPPEN
<b>MODELLEN:</b>	
CITIGO (2012-2015)	ROOMSTER (2013-2015)
FABIA (2013-2014)	SUPERB (2013-2015)
RAPID (2013-2015)	YETI (2013-2015)

#### VAG GROUP



VAG-R002

#### EIGENSCHAPPEN:

<b>TRANSPONDER:</b>	NEE
<b>KEYLESS:</b>	NEE
<b>FREQUENTIE</b>	433 MHZ
<b>BATTERIJ:</b>	CR2032
<b>ORIGINELE NUMMER:</b>	1J0959753AG, 1J0959753CT
<b>NOODSLEUTEL:</b>	NEE
<b>PROFIEL:</b>	
<b>MODEL:</b>	2 KNOPPEN
<b>MODELLEN:</b>	
FABIA (2001-2009)	ROOMSTER (-2006)
OCTAVIA (2002-2005)	

#### VAG GROUP



VAG-R003

#### EIGENSCHAPPEN:

<b>TRANSPONDER:</b>	NEE
<b>KEYLESS:</b>	NEE
<b>FREQUENTIE</b>	433 MHZ
<b>BATTERIJ:</b>	CR2032
<b>ORIGINELE NUMMER:</b>	1J0959753DA
<b>NOODSLEUTEL:</b>	NEE
<b>PROFIEL:</b>	
<b>MODEL:</b>	3 KNOPPEN
<b>MODELLEN:</b>	
OCTAVIA	

## AUTOSLEUTELS EN AFSTANDSBEDIENINGEN

AFBEELDING:

ART. NR.:

OMSCHRIJVING:

### SMART

SMART FORTWO 451



SMA-  
R001

#### EIGENSCHAPPEN:

TRANSPONDER: PCF7941

KEYLESS: NEE

FREQUENTIE 434 MHZ

BATTERIJ: CR2016

ORIGINELE NUMMER:

NOODSLEUTEL: NEE

PROFIEL:

MODEL: 3 KNOPPEN

MODELLEN:

FORTWO (2007-2015)

SMART FORTWO 451  
INFRAROED



SMA-  
R002

#### EIGENSCHAPPEN:

TRANSPONDER: IR

KEYLESS: NEE

FREQUENTIE 434 MHZ

BATTERIJ: CR1220

ORIGINELE NUMMER:

NOODSLEUTEL: NEE

PROFIEL: YM23

MODEL: 3 KNOPPEN

MODELLEN:

FORTWO (1999+)

SMART FORTWO 453



SMA-  
R003

#### EIGENSCHAPPEN:

TRANSPONDER: PCF7961M

KEYLESS: NEE

FREQUENTIE 433 MHZ

BATTERIJ: CR2032

ORIGINELE NUMMER:

NOODSLEUTEL: NEE

PROFIEL: PG33 - VA2

MODEL: 3 KNOPPEN

MODELLEN:

FORTWO (2014+)

FORFOUR (2015-2017)



## AUTOSLEUTELS EN AFSTANDBEDIENINGEN

AFBEELDING:	ART. NR.:	OMSCHRIJVING:
-------------	-----------	---------------

### SMART

SMART 450



SMA-  
R004

#### EIGENSCHAPPEN:

TRANSPONDER:	PCF7941
KEYLESS:	NEE
FREQUENTIE	434 MHZ
BATTERIJ:	CR2016
ORIGINELE NUMMER:	
NOODSLEUTEL:	NEE
PROFIEL:	YM23
MODEL:	3 KNOPPEN
MODELLEN:	PASSION (2000-2004)
FORTWO (2003-2006)	PULSE (2000-2004)
CITY (2000-2004)	ROADSTER (2003-2006)

## AUTOSLEUTELS EN AFSTANDSBEDIENINGEN

AFBEELDING:	ART. NR.:	OMSCHRIJVING:
-------------	-----------	---------------

### SUZUKI

SUZUKI



SUZ-R001

#### EIGENSCHAPPEN:

<b>TRANSPONDER:</b>	HITAG3 MODEL T61MO
<b>KEYLESS:</b>	NEE
<b>FREQUENTIE</b>	433 MHZ
<b>BATTERIJ:</b>	
<b>ORIGINELE NUMMER:</b>	
<b>NOODSLEUTEL:</b>	NEE
<b>PROFIEL:</b>	
<b>MODEL:</b>	2 KNOPPEN
<b>MODELLEN:</b>	SWIFT (7.2010-2015)

SUZUKI



SUZ-R002

#### EIGENSCHAPPEN:

<b>TRANSPONDER:</b>	HITAG3 37182-79M00
<b>KEYLESS:</b>	NEE
<b>FREQUENTIE</b>	433 MHZ
<b>BATTERIJ:</b>	
<b>ORIGINELE NUMMER:</b>	98970Y162531553
<b>NOODSLEUTEL:</b>	NEE
<b>PROFIEL:</b>	
<b>MODEL:</b>	2 KNOPPEN
<b>MODELLEN:</b>	GRAN VITARA (-2006) SWIFT (2004-2010) SPLASH (2008-2010)

SUZUKI



SUZ-R003

<b>TRANSPONDER:</b>	PCF7936
<b>KEYLESS:</b>	NEE
<b>FREQUENTIE</b>	433 MHZ
<b>BATTERIJ:</b>	
<b>ORIGINELE NUMMER:</b>	
<b>NOODSLEUTEL:</b>	NEE
<b>PROFIEL:</b>	SU19 - HU133
<b>MODEL:</b>	2 KNOPPEN
<b>MODELLEN:</b>	GRAN VITARA 2006+ FIAT 16 2001+ SPLASH (2008-2010) OPEL AGILA 2006+ SWIFT (2004-2010)

## AUTOSLEUTELS EN AFSTANDSBEDIENINGEN

AFBEELDING:	ART. NR.:	OMSCHRIJVING:
-------------	-----------	---------------

### TOYOTA

#### TOYOTA



TOY-R005

#### EIGENSCHAPPEN:

<b>TRANSPONDER:</b>	PCF7961
<b>KEYLESS:</b>	NEE
<b>FREQUENTIE</b>	434 MHZ
<b>BATTERIJ:</b>	CR2016
<b>ORIGINELE NUMMER:</b>	
<b>NOODSLEUTEL:</b>	NEE
<b>PROFIEL:</b>	
<b>MODEL:</b>	2 KNOPPEN
<b>MODELLEN:</b>	
	YARIS (2014+)
	RAV4 (2014+)

#### TOYOTA



TOY-R006

#### EIGENSCHAPPEN:

<b>TRANSPONDER:</b>	PCF7961
<b>KEYLESS:</b>	NEE
<b>FREQUENTIE</b>	433 MHZ
<b>BATTERIJ:</b>	CR2016
<b>ORIGINELE NUMMER:</b>	
<b>NOODSLEUTEL:</b>	NEE
<b>PROFIEL:</b>	
<b>MODEL:</b>	3 KNOPPEN
<b>MODELLEN:</b>	
	YARIS (2014+)
	RAV4 (2014+)

## AUTOSLEUTELS EN AFSTANDBEDIENINGEN

AFBEELDING:	ART. NR.:	OMSCHRIJVING:
-------------	-----------	---------------

### VOLKSWAGEN

#### VAG UDS



VAG-R001

#### EIGENSCHAPPEN:

<b>TRANSPONDER:</b>	ID48 CANBUS (EXCLUSIEF)
<b>KEYLESS:</b>	NEE
<b>FREQUENTIE</b>	433 MHZ
<b>BATTERIJ:</b>	CR2032
<b>ORIGINELE NUMMER:</b>	7N583202H, 5K0837202AD 3T0959753L, 7E0837202BD 7E0837202AF
<b>PROFIEL:</b>	V66 - HU66
<b>MODEL:</b>	2 KNOPPEN
<b>MODELLEN:</b>	
BEETLE (2011-2013)	BEETLE CABRIO ('11-'13)
CADDY (2011-2014)	SHARAN (2011+)
EOS (2011-2013)	TIGUAN (2011-2013)
GOLF 6 (2011-2013)	TOURAN (2011-2013)
GOLF CABRIO ('11-'13)	TRANSPORTER T5 ('11-'15)
JETTA (2012-2013)	AMAROK (2012-2015)
POLO (2011+)	UP (2011-2013)
SCIROCCO (2011-2013)	

#### VAG GROUP



VAG-R002

#### EIGENSCHAPPEN:

<b>TRANSPONDER:</b>	NEE
<b>KEYLESS:</b>	NEE
<b>FREQUENTIE</b>	433 MHZ
<b>BATTERIJ:</b>	CR2032
<b>ORIGINELE NUMMER:</b>	1J0959753AG, 1J0959753CT
<b>NOODSLEUTEL:</b>	NEE
<b>PROFIEL:</b>	
<b>MODEL:</b>	2 KNOPPEN
<b>MODELLEN:</b>	
GOLF 4 (1998-2001)	PASSAT 4 (1998-2011)
JETTA (1998-2001)	

## AUTOSLEUTELS EN AFSTANDSBEDIENINGEN

AFBEELDING:	ART. NR.:	OMSCHRIJVING:
-------------	-----------	---------------

### VOLKSWAGEN

#### VAG GROUP



VAG-R003

#### EIGENSCHAPPEN:

TRANSPONDER:	NEE
KEYLESS:	NEE
FREQUENTIE	433 MHZ
BATTERIJ:	CR2032
ORIGINELE NUMMER:	1J0959753DA
NOODSLEUTEL:	NEE
PROFIEL:	
MODEL:	3 KNOPPEN
MODELLEN:	
GOLF	CADDY
JETTA	

#### VOLKSWAGEN PASSAT



VAG-R004

#### EIGENSCHAPPEN:

TRANSPONDER:	ID48 CANBUS
KEYLESS:	NEE
FREQUENTIE	433 MHZ
BATTERIJ:	CR2032
ORIGINELE NUMMER:	3CO959752BA
NOODSLEUTEL:	NEE
PROFIEL:	V66 - HU66
MODEL:	3 KNOPPEN
MODELLEN:	
PASSAT (2005-2014)	
PASSAT CC (2008-2015)	

#### VOLKSWAGEN



VAG-R005

#### EIGENSCHAPPEN:

TRANSPONDER:	NEE
KEYLESS:	NEE
FREQUENTIE	433 MHZ
BATTERIJ:	CR2032
ORIGINELE NUMMER:	1J0759753A
NOODSLEUTEL:	NEE
PROFIEL:	
MODEL:	2 KNOPPEN
MODELLEN:	
GOLF 4 (1998-2001)	PASSAT 4 (1998-2011)
JETTA (1998-2001)	

## AUTOSLEUTELS EN AFSTANDSBEDIENINGEN

AFBEELDING:	ART. NR.:	OMSCHRIJVING:
-------------	-----------	---------------

### VOLKSWAGEN

#### VW TOUAREG / PHAETON



#### EIGENSCHAPPEN:

<b>TRANSPONDER:</b>	ID46
<b>KEYLESS:</b>	NEE
<b>FREQUENTIE</b>	433 MHZ
<b>BATTERIJ:</b>	CR2032
<b>VAG-R006 ORIGINELE NUMMER:</b>	3D0959753AK, 3D0959753AA, 3D0959753AM
<b>NOODSLEUTEL:</b>	NEE
<b>PROFIEL:</b>	V66 - HU66
<b>MODEL:</b>	3 KNOPPEN
<b>MODELLEN:</b>	PHAETON (2002-2009) TOUAREG (2002-2010)

#### VW GOLF 7



#### EIGENSCHAPPEN:

<b>TRANSPONDER:</b>	ID48 MEGAMOS 88
<b>KEYLESS:</b>	JA
<b>FREQUENTIE</b>	433 MHZ
<b>BATTERIJ:</b>	
<b>VAG-R007 ORIGINELE NUMMER:</b>	
<b>SMART CARD</b>	3C0959752BA
<b>5G0959753</b>	5G0959753BJ
<b>6V0959753D</b>	5G0959753AA
<b>NOODSLEUTEL:</b>	
<b>PROFIEL:</b>	
<b>MODEL:</b>	
<b>MODELLEN:</b>	GOLF 7

#### T-CROSS MQB KEYLESS



#### EIGENSCHAPPEN:

<b>TRANSPONDER:</b>	AES ID48
<b>KEYLESS:</b>	JA
<b>FREQUENTIE</b>	434 MHZ
<b>BATTERIJ:</b>	
<b>VAG-R008 ORIGINELE NUMMER:</b>	
<b>NOODSLEUTEL:</b>	NEE
<b>PROFIEL:</b>	
<b>MODEL:</b>	3 KNOPPEN
<b>MODELLEN:</b>	T-CROSS

## AUTOSLEUTELS EN AFSTANDSBEDIENINGEN

AFBEELDING:	ART. NR.:	OMSCHRIJVING:
-------------	-----------	---------------

### VOLKSWAGEN

#### TOUAREG



#### EIGENSCHAPPEN:

<b>TRANSPONDER:</b>	
<b>KEYLESS:</b>	JA
<b>FREQUENTIE</b>	434 MHZ
<b>BATTERIJ:</b>	
<b>VAG-R009 ORIGINELE NUMMER:</b>	
<b>NOODSLEUTEL:</b>	
<b>PROFIEL:</b>	
<b>MODEL:</b>	3 KNOPPEN
<b>MODELLEN:</b>	
TOUAREG	

#### GOLF 7 TOUAREG



#### EIGENSCHAPPEN:

<b>TRANSPONDER:</b>	ID48
<b>KEYLESS:</b>	NEE
<b>FREQUENTIE</b>	434 MHZ
<b>BATTERIJ:</b>	CR2032
<b>VAG-R010 ORIGINELE NUMMER:</b>	ID:2015DJ1678 5E0959752D
<b>NOODSLEUTEL:</b>	
<b>PROFIEL:</b>	HU162U - HU162T
<b>MODEL:</b>	3 KNOPPEN
<b>MODELLEN:</b>	
GOLF 7 (2014)	
TOUAREG (2016)	

#### VOLKSWAGEN



#### EIGENSCHAPPEN:

<b>TRANSPONDER:</b>	ID48 NIET AANWEZIG
<b>KEYLESS:</b>	NEE
<b>FREQUENTIE</b>	433 MHZ
<b>BATTERIJ:</b>	CR2032
<b>VAG-R011 ORIGINELE NUMMER:</b>	7M3959753
<b>NOODSLEUTEL:</b>	NEE
<b>PROFIEL:</b>	
<b>MODEL:</b>	3 KNOPPEN
<b>MODELLEN:</b>	

## AUTOSLEUTELS EN AFSTANDBEDIENINGEN

AFBEELDING:

ART. NR.:

OMSCHRIJVING:

### VOLKSWAGEN

VOLKSWAGEN



EIGENSCHAPPEN:

<b>TRANSPONDER:</b>	ID48
<b>KEYLESS:</b>	NEE
<b>FREQUENTIE</b>	433 MHZ
<b>VAG-R012 BATTERIJ:</b>	CR2032
<b>ORIGINELE NUMMER:</b>	1K0959753G
<b>NOODSLEUTEL:</b>	NEE
<b>PROFIEL:</b>	
<b>MODEL:</b>	3 KNOPPEN
<b>MODELLEN:</b>	

VOLKSWAGEN



EIGENSCHAPPEN:

<b>TRANSPONDER:</b>	ID48
<b>KEYLESS:</b>	NEE
<b>FREQUENTIE</b>	433 MHZ
<b>VAG-R013 BATTERIJ:</b>	
<b>ORIGINELE NUMMER:</b>	1J0959753DA
<b>NOODSLEUTEL:</b>	NEE
<b>PROFIEL:</b>	
<b>MODEL:</b>	3 KNOPPEN
<b>MODELLEN:</b>	



## AUTOSLEUTELS EN AFSTANDSBEDIENINGEN

AFBEELDING:	ART. NR.:	OMSCHRIJVING:
-------------	-----------	---------------

### VOLKSWAGEN

#### VOLKSWAGEN



#### EIGENSCHAPPEN:

VAG-R015

TRANSPONDER:	ID48 NIET AANWEZIG
KEYLESS:	NEE
FREQUENTIE	433 MHZ
BATTERIJ:	CR2032
ORIGINELE NUMMER:	1J0959753AH
NOODSLEUTEL:	NEE
PROFIEL:	
MODEL:	3 KNOPPEN
MODELLEN:	

#### VOLKSWAGEN



#### EIGENSCHAPPEN:

VAG-R016

TRANSPONDER:	ID48 NIET AANWEZIG
KEYLESS:	NEE
FREQUENTIE	433 MHZ
BATTERIJ:	CR2032
ORIGINELE NUMMER:	1J0959753G
NOODSLEUTEL:	NEE
PROFIEL:	
MODEL:	3 KNOPPEN
MODELLEN:	



#### EIGENSCHAPPEN:

VAG-R017

TRANSPONDER:	ID48 NIET AANWEZIG
KEYLESS:	NEE
FREQUENTIE	433 MHZ
BATTERIJ:	CR2032
ORIGINELE NUMMER:	1J0959753DA
NOODSLEUTEL:	NEE
PROFIEL:	
MODEL:	3 KNOPPEN
MODELLEN:	

## AUTOSLEUTELS EN AFSTANDSBEDIENINGEN

AFBEELDING:

ART. NR.:

OMSCHRIJVING:

### VOLKSWAGEN

VOLKSWAGEN



VAG-R018

EIGENSCHAPPEN:

TRANSPONDER:	ID48 NIET AANWEZIG
KEYLESS:	NEE
FREQUENTIE	433 MHZ
BATTERIJ:	CR2032
ORIGINELE NUMMER:	1J0959753
NOODSLEUTEL:	NEE
PROFIEL:	
MODEL:	3 KNOPPEN
MODELLEN:	

VOLKSWAGEN



VAG-R019

EIGENSCHAPPEN:

TRANSPONDER:	ID48
KEYLESS:	NEE
FREQUENTIE	433 MHZ
BATTERIJ:	CR2032
ORIGINELE NUMMER:	5K0959753AG/5K0837202AJ
NOODSLEUTEL:	NEE
PROFIEL:	
MODEL:	3 KNOPPEN
MODELLEN:	

VOLKSWAGEN



VAG-R020

EIGENSCHAPPEN:

TRANSPONDER:	ID48 NIET AANWEZIG
KEYLESS:	NEE
FREQUENTIE	433 MHZ
BATTERIJ:	CR2032
ORIGINELE NUMMER:	2E0959753DA
NOODSLEUTEL:	NEE
PROFIEL:	
MODEL:	3 KNOPPEN
MODELLEN:	

## AUTOSLEUTELS EN AFSTANDSBEDIENINGEN

AFBEELDING:	ART. NR.:	OMSCHRIJVING:
-------------	-----------	---------------

### VOLKSWAGEN

#### VOLKSWAGEN



VAG-R021

#### EIGENSCHAPPEN:

TRANSPONDER:	ID48 NIET AANWEZIG
KEYLESS:	NEE
FREQUENTIE	433 MHZ
BATTERIJ:	CR2032
ORIGINELE NUMMER:	5K0959753AB
NOODSLEUTEL:	NEE
PROFIEL:	
MODEL:	3 KNOPPEN
MODELLEN:	

#### VOLKSWAGEN



VAG-R022

#### EIGENSCHAPPEN:

TRANSPONDER:	MQB ID48
KEYLESS:	NEE
FREQUENTIE	433 MHZ
BATTERIJ:	CR2032
ORIGINELE NUMMER:	
NOODSLEUTEL:	
PROFIEL:	HU162
MODEL:	
MODELLEN:	
	NO KEYLESS GO

#### VOLKSWAGEN



VAG-R023

#### EIGENSCHAPPEN:

TRANSPONDER:	MQB ID48
KEYLESS:	NEE
FREQUENTIE	433 MHZ
BATTERIJ:	CR2032
ORIGINELE NUMMER:	
NOODSLEUTEL:	
PROFIEL:	HU162
MODEL:	
MODELLEN:	
	KEYLESS GO

## AUTOSLEUTELS EN AFSTANDSBEDIENINGEN

AFBEELDING:

ART. NR.:

OMSCHRIJVING:

### VOLKSWAGEN

#### VOLKSWAGEN



VAG-R024

#### EIGENSCHAPPEN:

TRANSPONDER:	MQB ID48
KEYLESS:	NEE
FREQUENTIE	433 MHZ
BATTERIJ:	CR2032
ORIGINELE NUMMER:	
NOODSLEUTEL:	
PROFIEL:	HU162
MODEL:	
MODELLEN:	
	KEYLESS GO



VAG-R025

#### EIGENSCHAPPEN:

TRANSPONDER:	MQB ID48
KEYLESS:	NEE
FREQUENTIE	433 MHZ
BATTERIJ:	CR2032
ORIGINELE NUMMER:	
NOODSLEUTEL:	
PROFIEL:	HU162
MODEL:	
MODELLEN:	
	KEYLESS GO

### VOLVO

#### VOLVO



VOL-R001

#### EIGENSCHAPPEN:

TRANSPONDER:	ID46 PCF7945/7953
KEYLESS:	NEE
FREQUENTIE	433 MHZ
BATTERIJ:	2045 - 2452
ORIGINELE NUMMER:	5WK49224
NOODSLEUTEL:	5WK49264
PROFIEL:	JA
MODEL:	
MODELLEN:	5 KNOPPEN
S60 (2011-2016)	V40 C. COUNTRY ('13-'16)
S80 (2010-2015)	V70 (2010-2016)
S80L (2010-2016)	XC60 (2009-2016)
V60 (2011-2016)	XC70 (2010-2016)



# AUTEL AFSTANDBEDIENINGEN

**AUTEL AFSTANDSBEDIENINGEN**

AFBEELDING:	ART. NR.:	OMSCHRIJVING:
	IKEYAT002AL	UNIVERSELE SMART AFSTANDSBEDIENING
	IKEYAT003AL	UNIVERSELE SMART AFSTANDSBEDIENING
	IKEYAT003BL	UNIVERSELE SMART AFSTANDSBEDIENING
	IKEYAT004CL	UNIVERSELE SMART AFSTANDSBEDIENING

## AUTEL AFSTANDBEDIENINGEN





AFBEELDING:	ART. NR.:	OMSCHRIJVING:
	IKEYAT004EL	UNIVERSELE SMART AFSTANDBEDIENING
	IKEYBW003AL	UNIVERSELE BMW SMART AFSTANDBEDIENING
	IKEYBW004AL	UNIVERSELE BMW SMART REMOTE
	IKEYCL004AL	UNIVERSLE CHRYSLER SMART AFSTANDBEDIENING

## AUTEL AFSTANDSBEDIENINGEN

AFBEELDING:	ART. NR.:	OMSCHRIJVING:
	IKEYFD004AL	UNIVERSELE FORD SMART AFSTANDSBEDIENING
	IKEYFD005AL	UNIVERSLE FORD SMART AFSTANDSBEDIENING
	IKEYGM0004AL	UNIVERSELE GM CADILAC SMART AFSTANDSBEDIENING
	IKEYHD004BL	UNIVERSELE HONDA SMART AFSTANDSBEDIENING



**AUTEL AFSTANDSBEDIENINGEN**

AFBEELDING:	ART. NR.:	OMSCHRIJVING:
	IKEYHY003AL	UNIVERSELE HYUNDAI SMART AFSTANDSBEDIENING
	IKEYHY004AL	UNIVERSELE HYUNDAI SMART AFSTANDSBEDIENING
	IKEYNS003AL	UNIVERSELE NISSAN SMART AFSTANDSBEDIENING
	IKEYNS004AL	UNIVERSLE NISSAN SMART AFSTANDSBEDIENING





# XHORSE AUTOSLEUTELS EN AFSTANDSBEDIENINGEN



## AUTOSLEUTELS EN AFSTANDSBEDIENINGEN

AFBEELDING:	ART. NR.:	OMSCHRIJVING:
	MH-RV-02	SMART REMOTE CS 4BT
	MH-RV-03	SMART REMOTE KF 3 BT
	MH-RV-21F	SMART REMOTE KF20 3BT + PANIC
	MH-RV-04	SUPER REMOTE DS, 3BT, INCLUSIEF SUPER CHIP



## AUTOSLEUTELS EN AFSTANDSBEDIENINGEN

AFBEELDING:	ART. NR.:	OMSCHRIJVING:
	MH-RV-05C	SUPER REMOTE MQB, 3BT
	MH-RV-21H	SUPER REMOTE KF21, 3BT
	MH-RV-18	WIRELESS REMOTE OPEL, 3BT + PANIC
	MH-RV-03C	WIRE REMOTE KF03, 3BT



## AUTOSLEUTELS EN AFSTANDSBEDIENINGEN

AFBEELDING:	ART. NR.:	OMSCHRIJVING:
	MH-RV-05B	WIRE REMOTE MQB
	MH-RV-06	WIRE REMOTE B5 3BT
	MH-RV-06B	WIRE REMOTE B5 2BT
	MH-RV-08	WIRE REMOTE A600



## AUTOSLEUTELS EN AFSTANDSBEDIENINGEN

AFBEELDING:	ART. NR.:	OMSCHRIJVING:
	MH-RV-13B	WIRE REMOTE TOYOTA
	MH-RV-15	WIRE REMOTE HYUNDAI
	MH-RV-21B	WIRE REMOTE KF20
	MH-RV-21	WIRE REMOTE KF22, 3BT + PANIC



## AUTOSLEUTELS EN AFSTANDSBEDIENINGEN

AFBEELDING:	ART. NR.:	OMSCHRIJVING:
	MH-RV-20B	WIRE REMOTE HYUNDAI
	MH-RV-09B	WIRE REMOTE DS
	MH-RV-10D	WIRE REMOTE HONDA
	MH-RV-13C	WIRE REMOTE TOYOTA





## AUTOSLEUTELS EN AFSTANDSBEDIENINGEN

AFBEELDING:	ART. NR.:	OMSCHRIJVING:
	MH-RV-07	WIRE REMOTE B5 (Extreme Black)
	MH-RV-23	WIRE REMOTE MAZDA
	MH-RV-B5W	WIRE REMOTE B5 (Waterbestendig)
	MH-RV-B5B	WIRE REMOTE B5 BLUE



## AUTOSLEUTELS EN AFSTANDSBEDIENINGEN

AFBEELDING:	ART. NR.:	OMSCHRIJVING:
	MH-RV-B5R	WIRE REMOTE B5 RED
	MH-RV-B5Y	WIRE REMOTE B5 YELLOW
	MH-RV-18B	WIRE REMOTE OPEL
	MH-RV-05H	WIRE REMOTE HYUNDAI



## AUTOSLEUTELS EN AFSTANDSBEDIENINGEN

AFBEELDING:	ART. NR.:	OMSCHRIJVING:
-------------	-----------	---------------



MH-RV-04H

WIRE REMOTE HYUNDAI LOS



MH-RV-10

WIRELESS REMOTE HONDA





# XHORSE SLEUTELBAARDEN

## XHORSE AUTOSLEUTEL BAARDEN

AFBEELDING:	ART. NR.:	OMSCHRIJVING:
-------------	-----------	---------------



MH-KB-01

SLEUTELBAARD PROFIEL TR47 (TOY43) VOOR  
TOYOTA



MH-KB-02

SLEUTELBAARD PROFIEL HD1 (HON66) VOOR  
HONDA



MH-KB-03





SLEUTELBAARD PROFIEL HY6 (HYN6) VOOR  
HYUNDAI







MH-KB-05

SLEUTELBAARD PROFIEL HY14 (HYN14) VOOR  
HYUNDAI

## XHORSE AUTOSLEUTEL BAARDEN



AFBEELDING:	ART. NR.:	OMSCHRIJVING:
	MH-KB-09	SLEUTELBAARD PROFIEL FD40 (HU101) VOOR FORD
	MH-KB-10	SLEUTELBAARD PROFIEL FD3 (FO21) VOOR FORD
	MH-KB-11	SLEUTELBAARD PROFIEL V35 (HU49) VOOR VAG
	MH-KB-12	SLEUTELBAARD PROFIEL TR49 (TOY49) VOOR TOYOTA

## XHORSE AUTOSLEUTEL BAARDEN

AFBEELDING:	ART. NR.:	OMSCHRIJVING:
	MH-KB-18	SLEUTELBAARD PROFIEL NS34 (NSN14) VOOR NISSAN
	MH-KB-19	SLEUTELBAARD PROFIEL V66 / AD66 (HU66) VOOR VAG
	MH-KB-20	SLEUTELBAARD PROFIEL SU19 (HU113R) VOOR SUZUKI
	MH-KB-21	SLEUTELBAARD PROFIEL MT8S (MIT11R) VOOR MITSUBISHI





## XHORSE AUTOSLEUTEL BAARDEN

AFBEELDING:	ART. NR.:	OMSCHRIJVING:
	MH-KB-22	SLEUTELBAARD PROFIEL VX2 (YM28) VOOR OPEL
	MH-KB-24	SLEUTELBAARD PROFIEL VX1 (HU46) VOOR OPEL
	MH-KB-25	SLEUTELBAARD PROFIEL VX5 / VX6 (HU100) VOOR OPEL
	MH-KB-28	SLEUTELBAARD PROFIEL RN30 LANG (NE73) VOOR RENAULT, PEUGEOT EN CITROEN

## XHORSE AUTOSLEUTEL BAARDEN

AFBEELDING:	ART. NR.:	OMSCHRIJVING:
	MH-KB-32	SLEUTELBAARD PROFIEL VX4 (HU43) VOOR OPEL
	MH-KB-33	SLEUTELBAARD PROFIEL TR46 (TOY47) VOOR TOYOTA
	MH-KB-41	SLEUTELBAARD PROFIEL PG83 (HU83) VOOR PEUGEOT - CITROEN
	MH-KB-42	SLEUTELBAARD PROFIEL RN30 (NE73) VOOR RENAULT, PEUGEOT EN CITROEN

## XHORSE AUTOSLEUTEL BAARDEN

AFBEELDING:	ART. NR.:	OMSCHRIJVING:	
	MH-KB-45	SLEUTELBAARD PROFIEL FT22 (SIP22) VOOR FIAT	
	MH-KB-49	SLEUTELBAARD PROFIEL VE20 (VAC102) VOOR RENAULT - DACIA	
	MH-KB-64E	SLEUTELBAARD PROFIEL HU162 (HU162) VOOR VAG	





# KEYLINE SLEUTELBAARDEN

**SLEUTELBAARDEN AUTOSLEUTELS KEYLINE**

AFBEELDING:	ART. NR.:	OMSCHRIJVING:
-------------	-----------	---------------



FD3-KF      SLEUTELBAARD VOOR FORD (MAVIK) F021P







FD21-KF      SLEUTELBAARD VOOR FORD (MAVIK) FO38R







FD40-KF      SLEUTELBAARD VOOR FORD (MAVIK) HU101



## SLEUTELBAARDEN AUTOSLEUTELS KEYLINE





AFBEELDING:	ART. NR.:	OMSCHRIJVING:
	FT22-KF	SLEUTELBAARD VOOR FIAT (MAVIK) SIP22
	HD1-KF	SLEUTELBAARD VOOR HONDA (MAVIK) HON66
	HY6-KF	SLEUTELBAARD VOOR HYUNDAI (MAVIK) HYN6
	MT1-KF	SLEUTELBAARD VOOR MITSUBISHI (MAVIK) MIT8

## SLEUTELBAARDEN AUTOSLEUTELS KEYLINE

AFBEELDING:	ART. NR.:	OMSCHRIJVING:
	MT8S-KF	SLEUTELBAARD VOOR MITSUBISHI (MAVIK) MIT11R
	NS34-KF	SLEUTELBAARD VOOR NISSAN (MAVIK) NSN14
	PG33-KF	SLEUTELBAARD VOOR PEUGEOT (MAVIK) VA2
	PG83-KF	SLEUTELBAARD VOOR PEUGEOT (MAVIK) HU83



## SLEUTELBAARDEN AUTOSLEUTELS KEYLINE

AFBEELDING:	ART. NR.:	OMSCHRIJVING:
	RN30-KF	SLEUTELBAARD VOOR RENAULT (MAVIK) NE73
	SU15-KF	SLEUTELBAARD VOOR SUZUKI (MAVIK) SZ12
	SU19-KF	SLEUTELBAARD VOOR SUZUKI (MAVIK) HU133
	SUB1-KF	SLEUTELBAARD VOOR SUBARU (MAVIK) DAT17

## SLEUTELBAARDEN AUTOSLEUTELS KEYLINE

AFBEELDING:	ART. NR.:	OMSCHRIJVING:
-------------	-----------	---------------



TR47-KF SLEUTELBAARD VOOR TOYOTA (MAVIK) TOY43



TR48-KF SLEUTELBAARD VOOR TOYOTA (MAVIK) TOY48



TR49-KF SLEUTELBAARD VOOR TOYOTA (MAVIK) TOY40



TR51-KF SLEUTELBAARD VOOR TOYOTA (MAVIK) TOY40

## SLEUTELBAARDEN AUTOSLEUTELS KEYLINE

AFBEELDING:	ART. NR.:	OMSCHRIJVING:
-------------	-----------	---------------



TR53-KF SLEUTELBAARD VOOR TOYOTA (MAVIK) TOY49



V66-KF SLEUTELBAARD VOOR VAG GROUP (MAVIK) HU66



VE25-KF SLEUTELBAARD VOOR RENAULT (MAVIK) HU136



VX5-KF SLEUTELBAARD VOOR OPEL (MAVIK) HU100

---

## SLEUTELBAARDEN AUTOSLEUTELS KEYLINE

---

AFBEELDING:

ART. NR.:

OMSCHRIJVING:

---



REN-S35

SLEUTELBAARD VOOR DACIA / RENAULT  
2014+  
PROFIEL VE20, VAC102



# AUTOSLEUTEL TOEBEHOREN



## AUTOSLEUTEL TOEBEHOREN

AFBEELDING:	ART. NR.:	OMSCHRIJVING:
	MS-04	100 MICRO SWITCHES VOOR AFSTANDBEDIENING
	MS-10	100 MICRO SWITCHES VOOR AFSTANDBEDIENING
	ASM-11	MICRO SWITCHES , ASSORTIMENTSDOOS VAN 10x20 STUKS
	BSK-33B	BORGSTIFTEN VOOR SLEUTELBAARDEN ASSORTIMENTSDOOS VAN 5 X 100 STUKS
	VVDI-PINS-33C	100 STUKS 1,6MM PINS

## AUTOSLEUTEL TOEBEHOREN

AFBEELDING:	ART. NR.:	OMSCHRIJVING:
	KST-42H	SLEUTELBAARD DE- EN MONTAGE TANG
	KST-42H1	VERVANGSTIFT 1,6 MM VOOR KST-42H
	KST-42H2	VERVANGSTIFT 1,4 MM VOOR KST-42H
	RF-IR	AFSTANDSBEDIENING TESTER
	TAS-71	TOOLSET VOOR AUTOSLEUTELS
	TOB-75	TRANSPONDER OPBERG BOX

## AUTOSLEUTEL TOEBEHOREN









AFBEELDING:	ART. NR.:	OMSCHRIJVING:
	POWER CABLE	AUTEL IM 608 PRO POWER CABLE
	AHS	DIGITALE MICROSCOOP











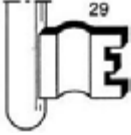

# BAARDSLEUTELS

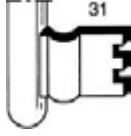
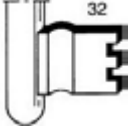

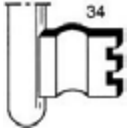
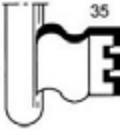





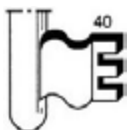

## BAARDSLEUTELS

AFBEELDING:	ART. NR.:	OMSCHRIJVING:
		<b>NEMEF 1366</b>
	1366-21	NEMEF KLAVIERSLEUTEL 1366-21
	1366-22	NEMEF KLAVIERSLEUTEL 1366-22
	1366-23	NEMEF KLAVIERSLEUTEL 1366-23
	1366-24	NEMEF KLAVIERSLEUTEL 1366-24
	1366-25	NEMEF KLAVIERSLEUTEL 1366-25
	1366-26	NEMEF KLAVIERSLEUTEL 1366-26
	1366-27	NEMEF KLAVIERSLEUTEL 1366-27
	1366-28	NEMEF KLAVIERSLEUTEL 1366-28

## BAARDSLEUTELS

AFBEELDING:	ART. NR.:	OMSCHRIJVING:
	1366-29	NEMEF KLAVIERSLEUTEL 1366-29
	1366-30	NEMEF KLAVIERSLEUTEL 1366-30
	1366-31	NEMEF KLAVIERSLEUTEL 1366-31
	1366-32	NEMEF KLAVIERSLEUTEL 1366-32
	1366-33	NEMEF KLAVIERSLEUTEL 1366-33
	1366-34	NEMEF KLAVIERSLEUTEL 1366-34
	1366-35	NEMEF KLAVIERSLEUTEL 1366-35
	1366-36	NEMEF KLAVIERSLEUTEL 1366-36
	1366-37	NEMEF KLAVIERSLEUTEL 1366-37
	1366-38	NEMEF KLAVIERSLEUTEL 1366-38

## BAARDSLEUTELS

AFBEELDING:	ART. NR.:	OMSCHRIJVING:
	1366-39	NEMEF KLAVIERSLEUTEL 1366-39
	1366-40	NEMEF KLAVIERSLEUTEL 1366-40
		<b>NEMEF 1200/1300</b>
	1210	NEMEF BAARDSLEUTEL 1210
	1220	NEMEF BAARDSLEUTEL 1220
	1230	NEMEF BAARDSLEUTEL 1230
	1240	NEMEF BAARDSLEUTEL 1240
	1250	NEMEF BAARDSLEUTEL 1250
	1300	NEMEF BAARDSLEUTEL 1300
	1400	NEMEF BAARDSLEUTEL 1400
	210	NEMEF BAARDSLEUTEL 210

**BAARDSLEUTELS**

AFBEELDING:	ART. NR.:	OMSCHRIJVING:
-------------	-----------	---------------











**NEMEF 91**



91-1	NEMEF KELDERBANDSLEUTEL 91-1
91-2	NEMEF KELDERBANDSLEUTEL 91-2
91-3	NEMEF KELDERBANDSLEUTEL 91-3
91-4	NEMEF KELDERBANDSLEUTEL 91-4
91-5	NEMEF KELDERBANDSLEUTEL 91-5
91-6	NEMEF KELDERBANDSLEUTEL 91-6
91-8	NEMEF KELDERBANDSLEUTEL 91-8
91-7	NEMEF KELDERBANDSLEUTEL 91-7
91-10	NEMEF KELDERBANDSLEUTEL 91-10
91-11	NEMEF KELDERBANDSLEUTEL 91-11

## BAARDSLEUTELS

AFBEELDING:	ART. NR.:	OMSCHRIJVING:
	91-12	NEMEF KELDERBANDSLEUTEL 91-12
	91-13	NEMEF KELDERBANDSLEUTEL 91-13
	91-14	NEMEF KELDERBANDSLEUTEL 91-14
	91-15	NEMEF KELDERBANDSLEUTEL 91-15
	91-16	NEMEF KELDERBANDSLEUTEL 91-16
	91-17	NEMEF KELDERBANDSLEUTEL 91-17
	91-18	NEMEF KELDERBANDSLEUTEL 91-18
	91-19	NEMEF KELDERBANDSLEUTEL 91-19
	91-20	NEMEF KELDERBANDSLEUTEL 91-20

## BAARDSLEUTELS

AFBEELDING:	ART. NR.:	OMSCHRIJVING:
-------------	-----------	---------------



### Lips 2122

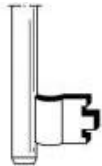

2122-961

LIPS KLAVIERSLEUTEL 2122-961

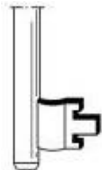

2122-962

LIPS KLAVIERSLEUTEL 2122-962

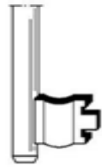

2122-963

LIPS KLAVIERSLEUTEL 2122-963



2122-964

LIPS KLAVIERSLEUTEL 2122-964



2122-965

LIPS KLAVIERSLEUTEL 2122-965



2122-966

LIPS KLAVIERSLEUTEL 2122-966

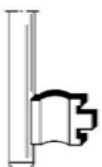

2122-967

LIPS KLAVIERSLEUTEL 2122-967

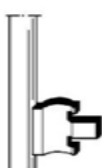

2122-968

LIPS KLAVIERSLEUTEL 2122-968

## BAARDSLEUTELS

AFBEELDING:	ART. NR.:	OMSCHRIJVING:
-------------	-----------	---------------



### Litto 675



675RH

LITTO KLAVIERSLEUTEL 675 RECHTS



675LH

LITTO KLAVIERSLEUTEL 675 LINKS

### Litto 57C



57C-0

LITTO KLAVIERSLEUTEL 57C  
ZONDER ZIJREEP



## BAARDSLEUTELS

AFBEELDING:	ART. NR.:	OMSCHRIJVING:
-------------	-----------	---------------



### BAARDSLEUTELS BLIND STAAL



2024-N

LIPS KLAVIERSLEUTEL 2024-N



315

TRANSFORMATORSLEUTEL BLIND



212

ERA RAAMSLEUTEL 212

### BORSTSLEUTELS BLIND



36-5,6

BORSTSLEUTEL DUNNE BAARD 5,6 MM



36-5,4

BORSTSLEUTEL DUNNE BAARD 5,4 MM



36-5,1

BORSTSLEUTEL DUNNE BAARD 5,1 MM



36-4,9

BORSTSLEUTEL DUNNE BAARD 4,9 MM



36-4,7

BORSTSLEUTEL DUNNE BAARD 4,7 MM





36-4,5

BORSTSLEUTEL DUNNE BAARD 4,5 MM

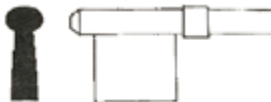
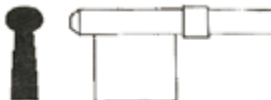

## BAARDSLEUTELS

AFBEELDING:	ART. NR.:	OMSCHRIJVING:
	330-6,5	BORSTSLEUTEL BLIND 6,5 MM
	330-7	BORSTSLEUTEL BLIND 7 MM

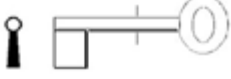
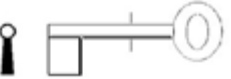



## PIJPSLEUTELS BLIND

	335-5	PIJPSLEUTEL BLIND 5 MM
	335-5,5	PIJPSLEUTEL BLIND 5,5 MM
	335-6	PIJPSLEUTEL BLIND 6 MM
	335-8	PIJPSLEUTEL BLIND 8 MM



## DOPSLEUTELS BLIND

	301-4,5	DOPSLEUTEL BLIND 4,5 MM
	301-5	DOPSLEUTEL BLIND 5 MM
	301-5,5	DOPSLEUTEL BLIND 5,5 MM

## BAARDSLEUTELS

AFBEELDING:	ART. NR.:	OMSCHRIJVING:
	301-6	DOPSLEUTEL BLIND 6 MM
	301-6,5	DOPSLEUTEL BLIND 6,5 MM
	301-7	DOPSLEUTEL BLIND 7 MM
	301-7,5	DOPSLEUTEL BLIND 7,5 MM
	301-8	DOPSLEUTEL BLIND 8 MM

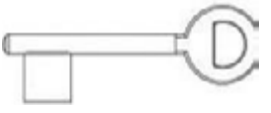
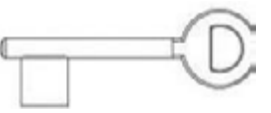
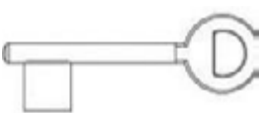
## **DOPSLEUTELS BLIND MESSING VERNIKKELD**

	126D-55	DOPSLEUTEL BLIND 5,5 MM
	126D-60	DOPSLEUTEL BLIND 6 MM
	126D-65	DOPSLEUTEL BLIND 6,5 MM
	126D-70	DOPSLEUTEL BLIND 7 MM

## BAARDSLEUTELS

AFBEELDING:	ART. NR.:	OMSCHRIJVING:
-------------	-----------	---------------

## DOORSLEUTELS



CV

CV ONTLUCHTINGSSLEUTEL

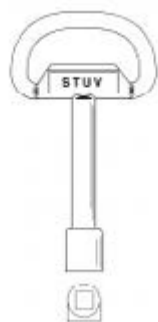

663

DOORSLEUTEL 7 MM VIERKANT



664

DOORSLEUTEL 8 MM VIERKANT



666

DOORSLEUTEL 8 MM DRIEKANT

## BAARDSLEUTELS

AFBEELDING:	ART. NR.:	OMSCHRIJVING:
	668	DOORNSLEUTEL 7 MM DRIEKANT
	670	DOORNSLEUTEL HALVE MAAN 11,5 MM
	20D-7	DOORNSLEUTEL KORT 7 MM DRIEKANT
	20V-8	DOORNSLEUTEL KORT 8 MM VIERKANT
	20D-8	DOORNSLEUTEL KORT 8 MM DRIEKANT

## BAARDSLEUTELS

AFBEELDING:	ART. NR.:	OMSCHRIJVING:
-------------	-----------	---------------

## BOUWSLEUTELS



E707010008

MEGA  
MULTIFUNCTIONELE  
BOUWSLEUTEL  
MET VIERKANT 6,7 EN 8 AANSLUITING



HW-  
BSMMS01







BOUWSLEUTEL KUNSTSTOF









659

SLEUTEL BUITENVIERKANT CONISCH  
6-9 MM

## BAARDSLEUTELS

AFBEELDING:	ART. NR.:	OMSCHRIJVING:
	4-WEG	UNIVERSELE 4-WEG SLEUTEL VIERKANT 6 EN 8 MM, DRIEKANT 8MM EN HOOGSPANNING
	10D-6,5	DOORNSLEUTEL 6,5MM DRIEHOEK (55MM)
	10D-7	DOORNSLEUTEL 7MM DRIEHOEK (78MM)
	10D-8	DOORNSLEUTEL 8MM DRIEHOEK (78MM)
	10D-10	DOORNSLEUTELS 10MM DRIEHOEK (78MM)
	10DK-8	KUNSTSTOF DOORNSLEUTEL 8MM (40MM) KLEIN MODEL DRIEHOEK
	10DV-8	KUNSTSTOF DOORNSLEUTEL 8MM (40MM) KLEIN MODEL VIERKANT

## BAARDSLEUTELS

AFBEELDING:	ART. NR.:	OMSCHRIJVING:
	10HS	HOOGSPANNING SLEUTEL
	10LR	LAAGSPANNING SLEUTEL
	10KB	KROON BINNENWERK
	10V-6	DOORSLEUTEL 6MM VIERKANT (78MM)
	10V-7	DOORSLEUTEL 7MM VIERKANT (78MM)
	10V-8	DOORSLEUTEL 8MM VIERKANT (78MM)





# KLUISSLEUTELS

## KLUISSLEUTELS

AFBEELDING:	ART. NR.:	OMSCHRIJVING:
-------------	-----------	---------------



1125

STUV DUBBELBAARDSLEUTEL,  
60 X 5,5 MM

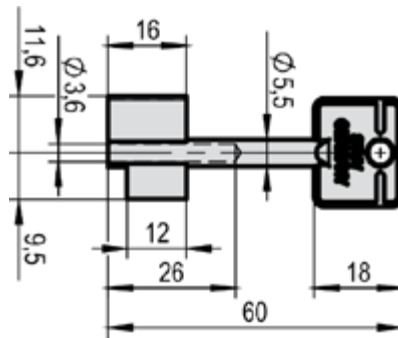

1132

STUV DUBBELBAARDSLEUTEL,  
170 X 5,5 MM

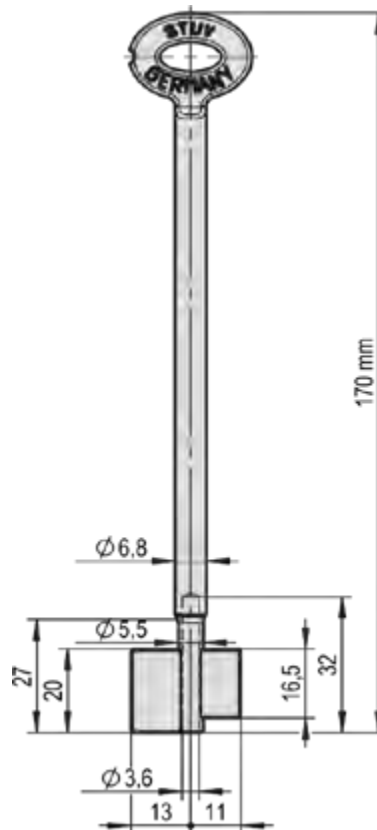

## KLUISSLEUTELS

AFBEELDING:	ART. NR.:	OMSCHRIJVING:
-------------	-----------	---------------



E700120016

BLINDE KLUISSLEUTEL 50 MM,  
 GESCHIKT VOOR CAWI, KLASSE 1

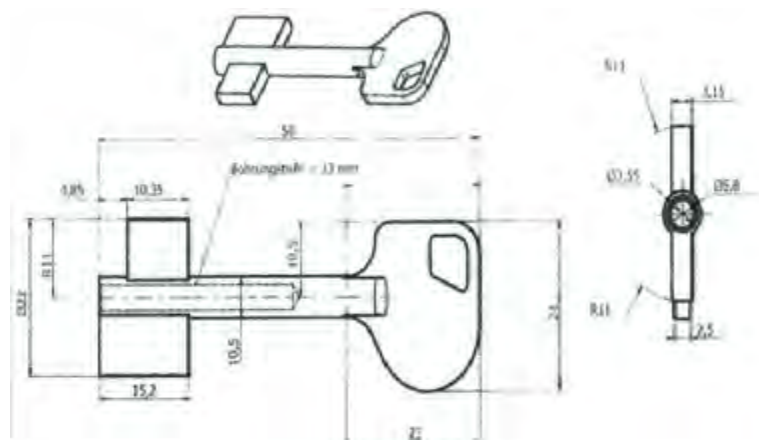

BLINDE KLUISSLEUTEL 65 MM,  
 E700120017 GESCHIKT VOOR CAWI, KLASSE 1 VANAF  
 MK3 EN GROTER

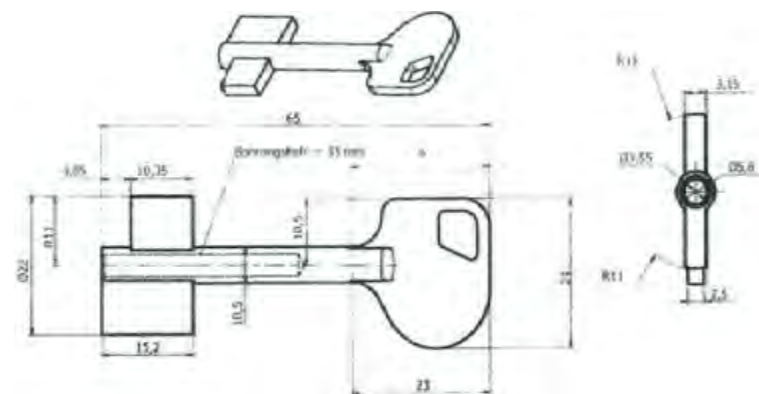

## KLUISSLEUTELS

AFBEELDING:	ART. NR.:	OMSCHRIJVING:
-------------	-----------	---------------



E700120018

BLINDE KLUISSLEUTEL 95 MM,  
GESCHIKT VOOR CAWI, KLASSE 1

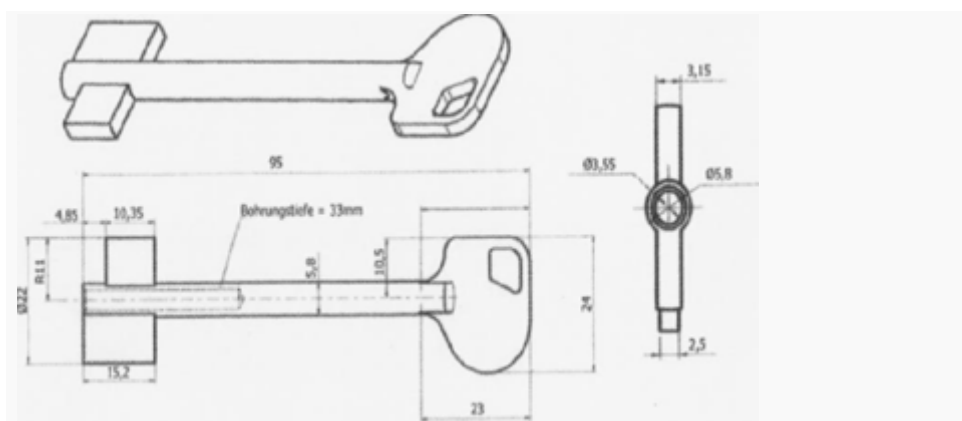

E700120019

BLINDE KLUISSLEUTEL 120 MM,  
GESCHIKT VOOR CAWI, KLASSE 1

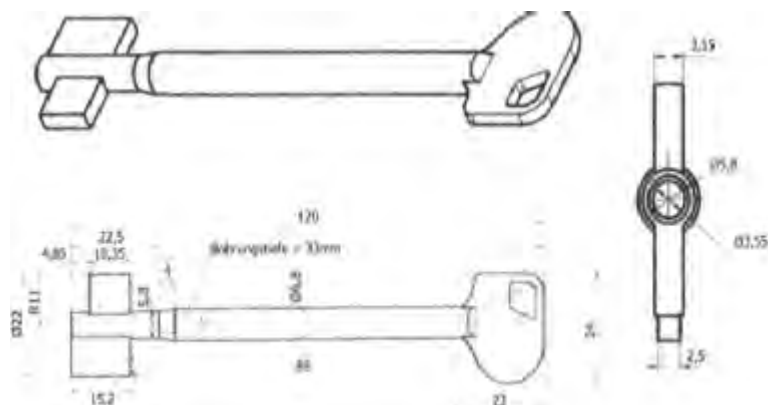

## KLUISSLEUTELS

AFBEELDING:	ART. NR.:	OMSCHRIJVING:
-------------	-----------	---------------



E700120020

BLINDE KLUISSLEUTEL 145 MM,  
 GESCHIKT VOOR CAWI, KLASSE 1

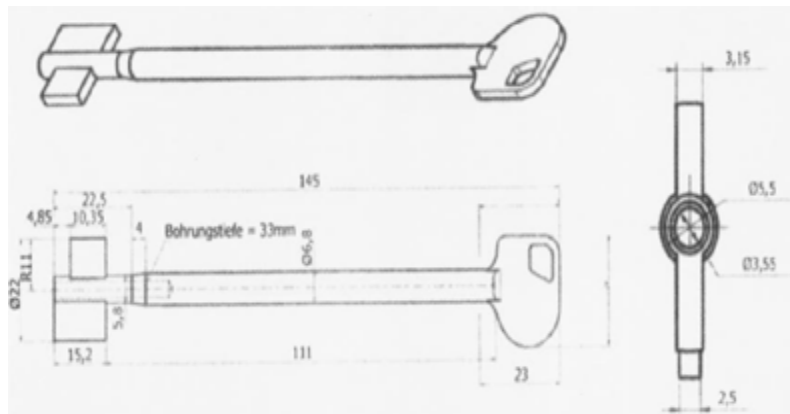

E700120021

SCHARNIERENDE BLINDE KLUISSLEUTEL 165  
 MM, GESCHIKT VOOR CAWI KLASSE 1 EN 2

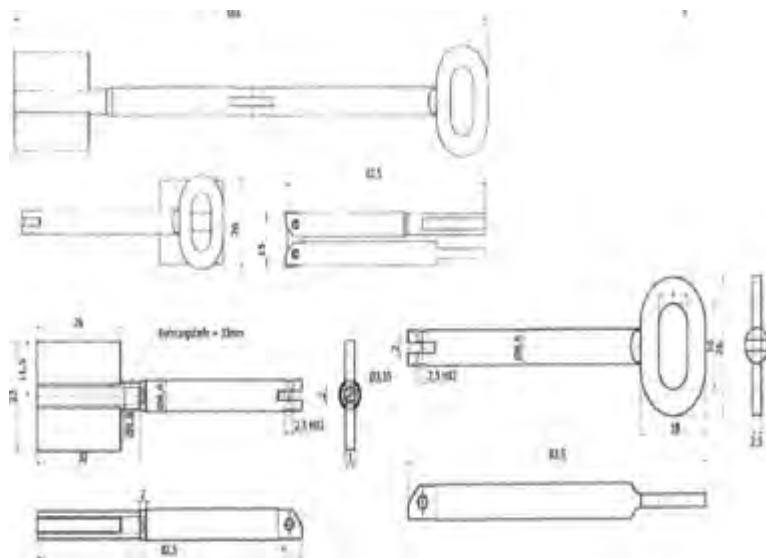

## KLUISSLEUTELS

AFBEELDING:	ART. NR.:	OMSCHRIJVING:
-------------	-----------	---------------



E700120022      SCHARNIERENDE BLINDE KLUISSLEUTEL 165  
MM, GESCHIKT VOOR KABA-MAUER KLASSE 2

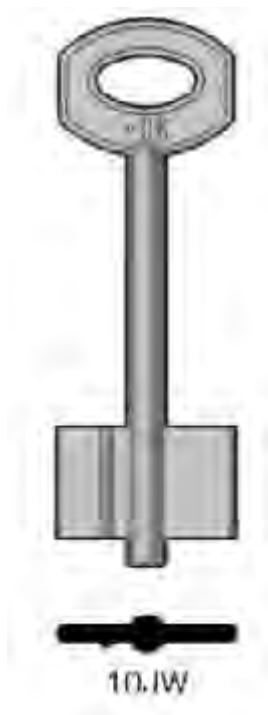
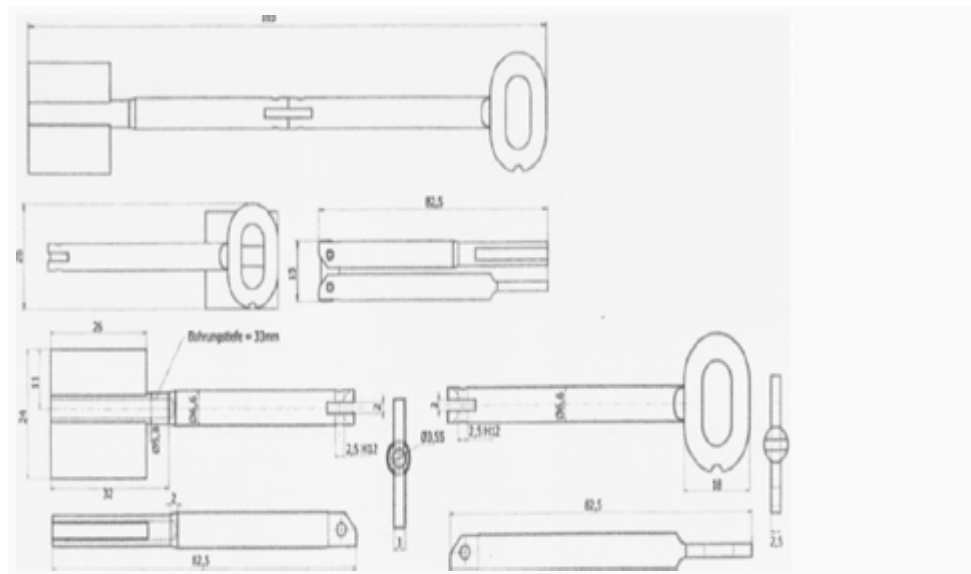









10JW      KLUISSLEUTEL JUWEL (SILCA 5JW1)



# OPENINGSGEREEDSCHAP

## OPENINGSGEREEDSCHAPPEN

AFBEELDING:	ART. NR.:	OMSCHRIJVING:
	20000S	KERNTREKKER GLOCKE
	2051	TREKSCHROEVEN 4,2 MM 10 STUKS
	2052	TREKSCHROEVEN 4,8 MM 10 STUKS
	2053	TREKSCHROEVEN 5,5 MM 10 STUKS
	SCRW1	MASTER TREKSCHROEVEN 4,2 MM 10 STUKS
	SCRW2	MASTER TREKSCHROEVEN 4,8 MM 10 STUKS
	SCRW3	MASTER TREKSCHROEVEN 5,8 MM 10 STUKS
	2132	TREKSCHROEFHOUDER TORX20
	20110	CILINDERKNAKKER MET INBUS









## OPENINGSGEREEDSCHAPPEN

AFBEELDING:	ART. NR.:	OMSCHRIJVING:
	SCB	STAARTCILINDER BREKER
	ACS2	CILINDERKNAKKER MET INBUS IN KOFFER
	PXP-10	13 DELIGE LOCK PICK SET IN LUXE LEREN ETUI
	LSM/2	SUPER MICA 5 STUKS ASSORTI
	LSM2/035	SUPER MICA 5 STUKS DUN 0.35MM
	3105	SET GEBROKEN SLEUTEL MEENEMERS
	BKES	PROFESSIONELE SET OM EEN AFGEBROKEN SLEUTEL TE VERWIJDEREN UIT DE CILINDER.

## OPENINGSGEREEDSCHAPPEN

AFBEELDING:	ART. NR.:	OMSCHRIJVING:
	UMK-S	SPECIALE BOUWSLEUTEL
	CG1	PROFIELCILINDERMETER
	MW01	CILINDERFREES VOOR O.A. DE MILWAUKEE 6 X 60 MM
	6322	CILINDERFREES VOOR O.A. DE MILWAUKEE 6 X 80 MM
	JIG1	SLOTKASTFREES INCLUSIEF 3 FREZEN (19, 22 EN 25 MM) ALLES IN EEN ROBUSTE KUNSTSTOF KOFFER
	CWB16	JIG BOORFREES VOOR HOUT 16,2 MM

## OPENINGSGEREEDSCHAPPEN

AFBEELDING:	ART. NR.:	OMSCHRIJVING:
	CWB18	JIG BOORFREES VOOR HOUT 17,5 MM
	CWB19	JIG BOORFREES VOOR HOUT 19 MM
	CWB20	JIG BOORFREES VOOR HOUT 20 MM
	CWB21	JIG BOORFREES VOOR HOUT 20,6 MM
	CWB22	JIG BOORFREES VOOR HOUT 22,2 MM
	CWB24	JIG BOORFREES VOOR HOUT 23,8 MM

## OPENINGSGEREEDSCHAPPEN

AFBEELDING:	ART. NR.:	OMSCHRIJVING:
-------------	-----------	---------------



CWB25

JIG BOORFREES VOOR HOUT 25,4 MM



UK





UNIVERSELE KLEM VOOR MOEILIJK IN TE SPANNEN BANEN- EN BORING SLEUTELS



HLC-45B

EENVOUDIGE TESTER VOOR HET SLEUTELPROFIEL OF HET SPIEGELBEELD VAN EEN SLEUTELPROFIEL

## OPENINGSGEREEDSCHAPPEN

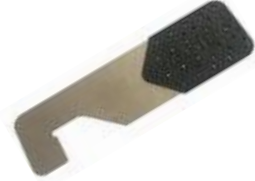
AFBEELDING:	ART. NR.:	OMSCHRIJVING:
	LSM-DOTKS	<p><b>LSM-DOTKS</b></p> <p>DIT IS EEN ROESTVRIJ STALEN DEUROPENER VOOR DEUREN DIE DICTH ZIJN GEVALLEN MAAR NIET IN HET SLOT ZIJN GEDRAAID. DIT IS EEN <b>KLEINE MAAT</b> MET EEN GEBOGEN HOEK <b>LINKS BOVEN</b>.</p>
	LSM-DOTNS	<p><b>LSM-DOTNS</b></p> <p>DIT IS EEN ROESTVRIJ STALEN DEUROPENER VOOR DEUREN DIE DICTH ZIJN GEVALLEN MAAR NIET IN HET SLOT ZIJN GEDRAAID. DIT IS EEN <b>KLEINE MAAT</b> MET EEN GEBOGEN HOEK <b>RECHTS BOVEN</b>.</p>
	LSM-DOTKL	<p><b>LSM-DOTKL</b></p> <p>DIT IS EEN ROESTVRIJ STALEN DEUROPENER VOOR DEUREN DIE DICTH ZIJN GEVALLEN MAAR NIET IN HET SLOT ZIJN GEDRAAID. GEEL IS EEN <b>MIDDEN MAAT</b> MET EEN GEBOGEN HOEK <b>LINKS BOVEN</b>.</p>
	LSM-DOTNL	<p><b>LSM-DOTNL</b></p> <p>DIT IS EEN ROESTVRIJ STALEN DEUROPENER VOOR DEUREN DIE DICTH ZIJN GEVALLEN MAAR NIET IN HET SLOT ZIJN GEDRAAID. ROOD IS EEN <b>MIDDEN MAAT</b> MET EEN GEBOGEN HOEK <b>RECHTS BOVEN</b>.</p>
	LSM-DOTNXL	<p><b>LSM-DOTNXL</b></p> <p>DIT IS EEN ROESTVRIJ STALEN DEUROPENER VOOR DEUREN DIE DICTH ZIJN GEVALLEN MAAR NIET IN HET SLOT ZIJN GEDRAAID. BLAUW IS EEN <b>XL MAAT</b> MET EEN GEBOGEN HOEK <b>LINKS BOVEN</b>.</p>
	LSM-RDO	<p><b>LSM-RDO</b></p> <p>DIT IS EEN ROESTVRIJ STALEN DEUROPENER VOOR DEUREN DIE DICTH ZIJN GEVALLEN MAAR NIET IN HET SLOT ZIJN GEDRAAID. ZWART IS MET EEN <b>HAAK</b>.</p>

## OPENINGSGEREEDSCHAPPEN

AFBEELDING:	ART. NR.:	OMSCHRIJVING:
	PSB	PENSLOT BREKER
	SKB	KERNTREKBEVEILIGING BREKER
	LSMK-ROSET	MASTER KERNTREKBEVEILIGING BREKER
	LSMK-STARTER	STARTERS KOFFER MET OPENSTEEKGEREEDSCHAPPEN. DEZE IS VOORZIEN VAN EEN KERNTREKBEVEILIGING BREKER, UNIVERSELE BOUWSLEUTEL EN EEN KNAKKER VOOR PROFIEL - EN RONDCILINDERS.
	LSMK-EXPERT	KOFFER VOOR DE EXPERT MET OPENSTEEKGEREEDSCHAPPEN. DEZE IS VOORZIEN VAN 2 KNAKKERS, 3 X 10 STUKS VERSCHILLENDE MATEN TREKSCHOEVEN. KERNTREKBEVEILIGING-BREKER, EEN TREKSCHOEFHOUDER EN 2 UNIVERSELE BOUWSLEUTELS.



# ACCESSOIRES

## SLEUTELACCESSOIRES

AFBEELDING	ART. NR.:	OMSCHRIJVING:
	10110-1	SLEUTELLABEL MET RING PER 100 STUKS ROOD
	10110-2	SLEUTELLABEL MET RING PER 100 STUKS BLAUW
	10110-3	SLEUTELLABEL MET RING PER 100 STUKS LICHT BLAUW
	10110-4	SLEUTELLABEL MET RING PER 100 STUKS ZWART
	10110-5	SLEUTELLABEL MET RING PER 100 STUKS GEEL
	10110-6	SLEUTELLABEL MET RING PER 100 STUKS GROEN
	10110-7	SLEUTELLABEL MET RING PER 100 STUKS LICHT GROEN
	10110-8	SLEUTELLABEL MET RING PER 100 STUKS ORANJE
	10110-9	SLEUTELABEL MET RING PER 100 STUKS BRUIN



## SLEUTELACCESSOIRES

AFBEELDING	ART. NR.:	OMSCHRIJVING:
	10110-10	SLEUTELLABEL MET RING PER 100 STUKS WIT
	10110-11	SLEUTELLABEL MET RING PER 100 STUKS GRIJS
	10110-12	SLEUTELLABEL MET RING PER 100 STUKS TRANSPARANT
	10110-13	SLEUTELLABEL MET RING PER 100 STUKS ROZE
	10110-14	SLEUTELLABEL MET RING PER 100 STUKS LILA
	10110-15	SLEUTELLABEL MET RING PER 100 STUKS TURQOIS
	1011-16	SLEUTELLABEL MET RING PER 100 STUKS PINK
	10110-17	SLEUTELLABEL MET RING PER 100 STUKS WIJNROOD
	10110-18	SLEUTELLABEL MET RING PER 100 STUKS GOUD



## SLEUTELACCESSOIRES

AFBEELDING	ART. NR.:	OMSCHRIJVING:
	10110-19	SLEUTELLABEL MET RING PER 100 STUKS ZILVER
	10110-20	SLEUTELLABEL MET RING PER 100 STUKS BEIGE
	10110-21	SLEUTELLABEL MET RING PER 100 STUKS NEON ROOD
	10110-22	SLEUTELLABEL MET RING PER 100 STUKS NEON BLAUW
	10110-23	SLEUTELLABEL MET RING PER 100 STUKS NEON PINK
	10110-24	SLEUTELLABEL MET RING PER 100 STUKS NEON ORANJE
	10110-25	SLEUTELLABEL MET RING PER 100 STUKS NEON GEEL
	10110-26	SLEUTELLABEL MET RING PER 100 STUKS NEON GROEN
	10110-27	SLEUTELLABEL MET RING PER 100 STUKS PAARS

## SLEUTELACCESSOIRES

AFBEELDING	ART. NR.:	OMSCHRIJVING:
	11110	ASSORTIMENT SLEUTELABELS MET RING. 10 X 20 STUKS
	11111	ASSORTIMENT SLEUTELABELS MET RING NEON 10 X 20 STUKS
	RED50	50 STUKS LUXE SLEUTELABELS ROOD 56x30MM - SCHRIJFVLAK 37x21MM
	BLU50	50 STUKS LUXE SLEUTELABELS BLAUW 56x30MM - SCHRIJFVLAK 37x21MM
	YEL50	50 STUKS LUXE SLEUTELABELS GEEL 56x30MM - SCHRIJFVLAK 37x21MM
	CLR50	50 STUKS LUXE SLEUTELABELS TRANSPARANT 56x30MM - SCHRIJFVLAK 37x21MM
	GRN50	50 STUKS LUXE SLEUTELABELS GROEN 56x30MM - SCHRIJFVLAK 37x21MM

## SLEUTELACCESSOIRES

AFBEELDING	ART. NR.:	OMSCHRIJVING:
	ORG50	50 STUKS LUXE SLEUTELABELS ORANJE
	AC100	100 STUKS LUXE SLEUTELABELS MIX COLOURS
	AC200	200 STUKS LUXE SLEUTELABELS MIX COLOURS

## KENNKAPPEN

	10220-1	100 KENNKAPPEN ROOD
	10220-2	100 KENNKAPPEN BLAUW
	10220-3	100 KENNKAPPEN LICHT BLAUW
	10220-4	100 KENNKAPPEN ZWART
	10220-5	100 KENNKAPPEN GEEL
	10220-6	100 KENNKAPPEN GROEN
	10220-7	100 KENNKAPPEN LICHT GROEN
	10220-10	100 KENNKAPPEN WIT
	10220-22	100 KENNKAPPEN NEON BLAUW







## SLEUTELACCESSOIRES

AFBEELDING	ART. NR.:	OMSCHRIJVING:
	10220-23	100 KENNKAPPEN NEON PINK
	10220-24	100 KENNKAPPEN ORANJE
	10220-25	100 KENNKAPPEN GEEL
	10220-26	100 KENNKAPPEN NEON GROEN
	11201	250 KENNKAPPEN 10 X 25 STUKS INCLUSIEF 5 NEON KLEUREN
	11801	200 KENNKAPPEN VIERKANT GROOT VOOR DOM, EVVA, WINKHAUS WILKA 5 X 40
	10351	100 KENNKAPPEN VIERKANT 10 X 10 STUKS
<b>SLEUTELRINGEN</b>		
	11301	250 SLEUTELRINGEN 10 X 25 STUKS INCLUSIEF 5 NEON KLEUREN

## SLEUTELACCESSOIRES

AFBEELDING	ART. NR.:	OMSCHRIJVING:
	11400	200 SLEUTELRINGEN <b>GROOT</b> 10 X 20 STUKS
	SL20	SLEUTELRING 20 MM, 100 STUKS
	SL26	SLEUTELRING 26 MM, 100 STUKS
	SL30	SLEUTELRING 30 MM, 100 STUKS
	SL38	SLEUTELRING 38 MM, 100 STUKS
	SL50	SLEUTELRING 50 MM, 50 STUKS
	SR25	SCHARNIERRING 25 MM
	SR32	SCHARNIERRING 32 MM

## SLEUTELACCESSOIRES

AFBEELDING	ART. NR.:	OMSCHRIJVING:
	SR38	SCHARNIERRING 38 MM
	SR51	SCHARNIERRING 51 MM
	40082	VERZAMELRING 64MM
	40083	VERZAMELRING 93MM
	40084	VERZAMELRING 124MM
	40086	VERZAMELRING 155MM

## SLEUTELACCESSOIRES

AFBEELDING	ART. NR.:	OMSCHRIJVING:
------------	-----------	---------------

### HOTELBALLEN



6465-1

HOTELBAL ALUMINIUM F1



6465K-1

HOTELBAL KORT ALUMINIUM F1



30443

DEELBARE SLEUTELRING, VERNIKKELD,  
PER STUK



PKR

KUNSTSTOF PULL KEY REEL MET NYLON DRAAD



MH-BC

12 GEKLEURDE MUSKETONHAKEN MET  
SCHROEFSLUITING



MH-ML

ASSORTIDOOS MET 16 SLEUTELHANGER  
ZAKLAMPJES VAN ALUMINIUM



## SLEUTELACCESSOIRES

AFBEELDING	ART. NR.:	OMSCHRIJVING:
------------	-----------	---------------

### VW DISPLAY RETRO



VW-DISPLAY

DISPLAY MET 12 RETRO SLEUTELHANGERS  
 VOLKSWAGEN , ZWARE KWALITEIT

AFBEELDING:

ART. NR.:

OMSCHRIJVING:



SCA09

BLIK VOOR SLEUTELS



PL-SL









PLASTIC RECLAME SLEUTEL









## RVS LETTERS EN SYMBOLEN









## PICTOGRAMMEN RVS

AFBEELDING:	ART. NR.:	OMSCHRIJVING:
	691000000	HUISNUMMER RVS 156MM HOOG, NR. 0
	691010000	HUISNUMMER RVS 156MM HOOG, NR 1
	691020000	HUISNUMMER RVS 156MM HOOG, NR. 2
	691030000	HUISNUMMER RVS 156MM HOOG, NR. 3
	691040000	HUISNUMMER RVS 156MM HOOG, NR. 4
	691050000	HUISNUMMER RVS 156MM HOOG, NR. 5
	691060000	HUISNUMMER RVS 156MM HOOG, NR. 6
	691070000	HUISNUMMER RVS 156MM HOOG, NR. 7





**PICTOGRAMMEN RVS**

AFBEELDING:	ART. NR.:	OMSCHRIJVING:
	6910800000	HUISNUMMER RVS 156MM HOOG, NR. 8
	6910900000	HUISNUMMER RVS 156MM HOOG, NR. 9
	6911100000	RVS LETTER A, 110MM HOOG
	6911200000	RVS LETTER B, 110MM HOOG
	6911300000	RVS LETTER C, 110MM HOOG

## PICTOGRAMMEN RVS

AFBEELDING:	ART. NR.:	OMSCHRIJVING:
	H01	PICTOGRAM "DUWEN" ROND 75 MM
	H02	PICTOGRAM " TREKKEN " ROND 75 MM
	H05	PICTOGRAM " DAMES-WC " ROND 75 MM
	H06	PICTOGRAM " HEREN-WC " ROND 75 MM
	H07	PICTOGRAM " INVALIDE " ROND 75 MM
	H08	PICTOGRAM " WC " ROND 75 MM
	H12	PICTOGRAM " NIET ROKEN " ROND 75 MM
	H13	PICTOGRAM " GEEN TOEGANG " ROND 75 MM

## PICTOGRAMMEN RVS

AFBEELDING:	ART. NR.:	OMSCHRIJVING:
	H15	PICTOGRAM " GARDEROBE " ROND 75 MM
	H17	PICTOGRAM " MOBIELE TELEFOON TOEGESTAAN " ROND 75 MM
	H18	PICTOGRAM " MOBIELE TELEFOON VERBODEN " ROND 75 MM
	H25	PICTOGRAM " KANTOOR " ROND 75 MM
	H27	PICTOGRAM " PRIVE " ROND 75 MM







## SMEERMIDDEL VOOR SLOTEN

## SMEERMIDDEL

AFBEELDING:	ART. NR.:	OMSCHRIJVING:
	8310001100	BRUNOX TOP-LOCK, 100ML SPECIAAL VOOR CILINDERSLOTEN, SMEERMIDDEL ZONDER GRAFIET
	8310001952	BRUNOX TOP-LOCK, 20 X 100ML <b>GRATIS DISPLAY</b> SPECIAAL VOOR CILINDERSLOTEN, SMEERMIDDEL ZONDER GRAFIET
	8310000100 8310000300	BRUNOX TURBO SPRAY, 100ML BRUNOX TURBO SPRAY, 300ML
	8310000500	BRUNOX TURBO SPRAY, 500ML POWER CLICK



## SLOTEN O.A. EURO-LOCKS

## SLOTEN

AFBEELDING:	ART. NR.:	OMSCHRIJVING:
-------------	-----------	---------------



0802-51 AUTOMAATSLOT 90 GRADEN RECHTS

0802-51-GS AUTOMAATSLOT 90 GRADEN RECHTS,  
GELIJKSLUITEND



0802-52 AUTOMAATSLOT 90 GRADEN LINKS

0802-52-GS AUTOMAATSLOT 90 GRADEN LINKS,  
GELIJKSLUITEND

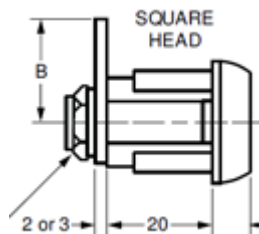

0802-53 AUTOMAATSLOT 180 GRADEN

0802-53-GS AUTOMAATSLOT 180 GRADEN,  
GELIJKSLUITEND



0806-51 ALS DE 0802 MAAR DAN MET RONDE  
VOORPLAAT, 90 GRADEN RECHTS







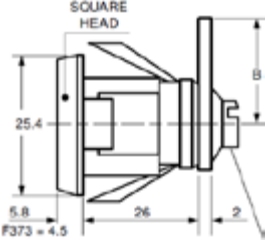
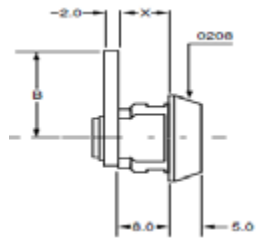
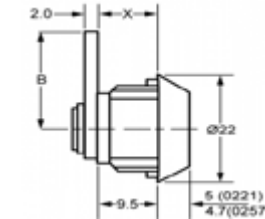

0806-52 ALS DE 0802 MAAR DAN MET RONDE  
VOORPLAAT, 90 GRADEN LINKS

0806-53 ALS DE 0802 MAAR DAN MET RONDE  
VOORPLAAT, 180 GRADEN



## SLOTEN

AFBEELDING:	ART. NR.:	OMSCHRIJVING:
	4202-51	AUTOMAATSLOT 90 GRADEN RECHTS, MAATVOERING ALS DE 0802, LIP AANSLUITING MET SCHROEF I.P.V. MOER. SLEUTEL SERIE 25000-27000
	1340-51	AUTOMAATSLOT 90 GRADEN RECHTS, LENGTE 22 MM
	1340-52	AUTOMAATSLOT 90 GRADEN LINKS, LENGTE 22 MM
	1341-51	AUTOMAATSLOT 90 GRADEN RECHTS, LENGTE 27 MM
	1341-52	AUTOMAATSLOT 90 GRADEN LINKS, LENGTE 27 MM
	1342-51	AUTOMAATSLOT 90 GRADEN RECHTS, LENGTE 32 MM
	1342-52	AUTOMAATSLOT 90 GRADEN LINKS, LENGTE 32 MM
	4239-51	AUTOMAATSLOT 90 GRADEN RECHTS

## SLOTEN

AFBEELDING:	ART. NR.:	OMSCHRIJVING:
	4239-53	AUTOMAATSLOT 180 GRADEN
	0201-53	AUTOMAATCILINDER RECHTS INCL. RECHTE SLUITLIP X = 8 MM
	0221-53	AUTOMAATCILINDER RECHTS INCL. RECHTE SLUITLIP X = 9,5 MM
	7A37	SLUITLIP RECHT VOOR 0802-0806 L= 37MM
	7A50	SLUITLIP RECHT VOOR 0802-0806 L= 50MM
	7A55	SLUITLIP RECHT VOOR 0802-0806 L= 55MM
	7B37	SLUITLIP GEBOGEN VOOR 0802-0806 L=37MM
	7B50	SLUITLIP GEBOGEN VOOR 0802-0806 L=50MM
	7B55	SLUITLIP GEBOGEN VOOR 0802-0806 L=55MM
	A32	SLUITLIP RECHT VOOR 1340-1341-1342 LENGTE VANAF HET HART GAT 32MM
	B32	SLUITLIP GEBOGEN VOOR 1340-1341-1342 LENGTE VANAF HET HART GAT 32MM

## SLOTEN

AFBEELDING:	ART. NR.:	OMSCHRIJVING:
	HS92	HOOFDSLEUTEL VOOR DE 1340 - 1341 - 1342
	HS45A	HOOFDSLEUTEL VOOR DE 0802 - 0806 serie 45.000 t/m 47.000
	HS25A	HOOFDSLEUTEL 4202- serie 25.000 t/m 27.000





A stylized graphic of three battery cells of increasing height, rendered in dark blue. The rightmost cell is partially obscured by a dark blue horizontal bar that contains the text 'BATTERIJEN'.

# BATTERIJEN

## BATTERIJEN

AFBEELDING:	ART. NR.:	OMSCHRIJVING:
-------------	-----------	---------------



VARTA-  
DISPLAY

DISPLAY MET 10 X 10 VERPAKKINGEN VARTA  
KNOOPCEL BATTERIJEN  
( TOTAAL 140 STUKS)



CR1216

VARTA CR1216 LITHIUM 3 VOLT



CR1220

VARTA CR1220 LITHIUM 3 VOLT









CR1225

VARTA CR1225 LITHIUM 3 VOLT

## BATTERIJEN



AFBEELDING:	ART. NR.:	OMSCHRIJVING:
	CR1616	VARTA CR1616 LITHIUM 3 VOLT
	CR1620	VARTA CR1620 LITHIUM 3 VOLT
	CR1632	VARTA CR1632 LITHIUM 3 VOLT
	CR2016	VARTA CR2016 LITHIUM 3 VOLT
	CR2025	VARTA CR2025 LITHIUM 3 VOLT

## BATTERIJEN

AFBEELDING:	ART. NR.:	OMSCHRIJVING:
	CR2032	VARTA CR2032 LITHIUM 3 VOLT
	CR2032-5	VARTA CR2032 LITHIUM 3 VOLT, VERPAKKING VAN 5 STUKS
	BAT-LIR2025	BATTERIJ 2025 VOOR BMW 3.6V
	BAT-LIR2032	BATTERIJ 2032 VOOR BMW 3,6V
	BAT-VL2020	BATTERIJ VOOR BMW/MINI 3V 90 GRADEN
	BAT-VL2020	BATTERIJ VOOR BMW/MINI 3V 180 GRADEN



## AFSTANDBEDIENINGEN

AFBEELDING:	ART. NR.:	OMSCHRIJVING:
	<p>TADA 4 ROOD</p> <p>TADA 4 BLAUW</p> <p>TADA 4 ZILVER</p>	<p>4 KNOPS AFSTANDBEDIENING, FREQUENTIE 433,92 MHz, FIXED CODE, 4 KANALEN, ZELF LEREND VOOR GARAGE DEUREN, POORTEN, ROLLUIKEN, VERLICHTING ETC.</p>
	<p>TADA 2 ROOD</p>	<p>2 KNOPS AFSTANDBEDIENING, FREQUENTIE 433,92 MHz, FIXED CODE, 2 KANALEN, ZELF LEREND VOOR GARAGE DEUREN, POORTEN, ROLLUIKEN, VERLICHTING ETC.</p>
	<p>TADA ALL ROOD</p> <p>TADA ALL BLAUW</p> <p>TADA ALL ZILVER</p>	<p>4 KNOPS AFSTANDBEDIENING, MULTI FREQUENTIE, FIXED EN ROLLING CODE, 4 KANALEN, ZELF LEREND VOOR GARAGE DEUREN, POORTEN, ROLLUIKEN, VERLICHTING ETC.</p>



# KEYLINE SLEUTELPRESENTATIE OPHANGSYSTEMEN

## KEYCENTER

AFBEELDING:	ART. NR.:	OMSCHRIJVING:
-------------	-----------	---------------



KC100

KAST MET 2 TREKSCHUIFDEUREN EN 4  
SCHAPPEN IN HET ONDERSTE GEDEELTE  
200x70x30 CM



KC200

WAND UNIT MET EEN KAST VOORZIEN VAN 5  
LADEN, ACHTERWAND EN KOOF MET LED  
VERLICHTING.  
200x65x60



KC300

WAND UNIT MET EEN KAST VOORZIEN VAN 1  
LADE EN DEUR, ACHTERWAND EN KOOF MET  
LED VERLICHTING.  
200x65x60



## KEYCENTER

AFBEELDING:	ART. NR.:	OMSCHRIJVING:
	KC210	KAST VOORZIEN VAN 5 LADEN + EEN VITRINEKAST 120x65x60
	KC310	KAST VOORZIEN VAN 1 LADE EN DEUR + EEN VITRINEKAST 120x65x60
	KC201	KAST VOORZIEN VAN 5 LADEN 90x65x60
	KC301	KAST VOORZIEN VAN 1 LADE EN DEUR 90x65x60
	KC010	HANDGREEP INCLUSIEF SCHROEVEN VOOR DE KEYCENTER

## KEYCENTER

AFBEELDING:	ART. NR.:	OMSCHRIJVING:
-------------	-----------	---------------



KC025

VERHOGING VOOR EEN SLEUTELMACHINE



GA070

WANDHAAK 7 CM  
H.O.H. 25 MM



GA090

WANDHAAK 9 CM  
H.O.H. 25 MM

## WAND DISPLAY



PA099

WAND DISPLAY MET 99 HAKEN,  
MAATVOERING 105X53 CM



# SLEUTELMACHINES

## SLEUTELMACHINES (MECHANISCH)

AFBEELDING:	ART. NR.:	OMSCHRIJVING:
	X-DU001A-4	<p><b>EASY QUATTRO</b></p> <p>Eenvoudige machine voor het dupliceren van cilinder-, auto- en stersleutels. Vierzijdige klemmen waardoor alle sleutels goed zijn in te spannen. HSS frees,</p>
	BI106-C4	<p><b>CARAT QUATTRO</b></p> <p>Voor het dupliceren van cilinder-, auto- en stersleutels. Vierzijdige klemmen waardoor alle sleutels goed zijn in te spannen. Voorzien van een krachtige motor, HSS frees, kunststof borstel, goede verlichting</p>
	BI106-C4W	<p><b>CARAT QUATTRO W</b></p> <p>Als de BI106-C4 maar dan met Widia frees i.p.v. een HSS frees.</p>
	X-DU004A	<p><b>PUNTO</b></p> <p>Voor het dupliceren van boring- en banensleutels. Voorzien van vaste bekken en zeer geschikt voor het frezen van auto-, fiets- en vlakke boringsleutels. Geïntegreerde LED verlichting.</p>

## SLEUTELMACHINES (MECHANISCH)

AFBEELDING:	ART. NR.:	OMSCHRIJVING:
	BI310	<p><b>T-REX</b></p> <p>Voor het dupliceren van boring-, banen- en tubular (buis) sleutels. Nieuw ontworpen spanbekken waardoor sleutels zeer goed zijn in te klemmen.</p> <p>Mechanisch/elektronische fijn afstelling van taster en frees.</p> <p>Geïntegreerde LED verlichting.</p>
	BI313	<p><b>T-REX PLUS</b></p> <p>Als de T-REX (BI310) maar dan met spanbekken die zijn te kantelen tot een hoek van 45 graden</p>
	BI312	<p><b>T-REX ADVANCED</b></p> <p>Als de T-REX PLUS (BI313) maar dan met motor gestuurde klembekken om de frees en taster eenvoudig te wisselen zonder gebruik van inbussleutels</p>
	BI204	<p><b>B1204</b></p> <p>Klaviersleutelmachine voor baard-, dubbelbaard, pijp- en pompsleutels. Ook het maken van zijreep insnijdingen is geen probleem.</p> <p>Voorzien van twee motorsnelheden.</p> <p>De lagering van de wagen zorgen ervoor dat er met soepele en precieze bewegingen kan worden gewerkt.</p>
	BI503-AB	<p><b>FALCON</b></p> <p>Voor het dupliceren van o.a. Abus Plus op code, standaard wordt de machine geleverd met een Abus klem.</p> <p>Er zijn diverse klemmen verkrijgbaar voor o.a. de Abloy en de Ford Tibbe.</p>

## SLEUTELMACHINES (ELEKTRONISCH)

AFBEELDING:	ART. NR.:	OMSCHRIJVING:
	BI503	<p><b>ARCADIA</b></p> <p>Voor het dupliceren van Tubular (buis) sleutels. Standaard wordt de machine geleverd met slede KT0 (meest universeel)</p> <p>De diverse leverbare sledes zijn eenvoudig uit te wisselen.</p>
	BI702	<p><b>CAMILLO BIANCHI READER</b></p> <p>Zeer snel en eenvoudig scannen van het sleutelprofiel. Binnen 20 seconden zijn de te gebruiken kopiesleutels zichtbaar op het 7 inch Touch screen. Alternatieve merken zoals Silca, Boerkey, JMA etc. worden ook weergegeven.</p>
	BI702-ADV	<p><b>CAMILLO BIANCHI READER ADVANCED</b></p> <p>Als de BI702 maar dan kun je ook zelf sleutelprofielen toe voegen net zoals haakposities. Blinde sleutels zijn dan nog sneller te vinden aan de sleutelwand.</p>
	BI-SW01	Software update van BI702 naar Bi702-ADV.
	BI995-DARK	<p><b>NINJA DARK</b></p> <p>Volautomatische <u>kopieermachine</u> voor cilinder-, ster- en autosleutels.</p>

## SLEUTELMACHINES (ELEKTRONISCH)





AFBEELDING:	ART. NR.:	OMSCHRIJVING:
	BI995	<p><b>NINJA</b></p> <p>Voor <b>cilinder- en autosleutels</b> op code. Sleutels zijn te decoderen en weer te frezen naar de originele fabriekswaarden. Ook direct een sleutel op code maken is geen probleem door de standaard meegeleverde software.</p>
	BI997	<p><b>NINJA LASER</b></p> <p>Voor <b>cilinder-, auto en banensleutels</b> op code. De sleutels zijn te decoderen en weer te frezen naar de originele fabriekswaarden. Ook direct een sleutel op code maken is geen probleem door de standaard meegeleverde software.</p>
	BI998	<p><b>NINJA VORTEX</b></p> <p>Voor <b>boring- en banensleutels</b> op code. De sleutels zijn te decoderen en weer te frezen naar de originele fabriekswaarden. Ook direct een sleutel op code maken is geen probleem door de standaard meegeleverde software.</p>
	BI999	<p><b>NINJA TOTAL</b></p> <p>Voor <b>cilinder-, boring- en banensleutels</b> op code. Deze alleskunner kan sleutels decoderen en weer frezen naar de originele fabriekswaarden. Ook direct een sleutel op code maken is geen probleem door de standaard meegeleverde software. Graveren van de sleutelkop is ook mogelijk.</p>

## SLEUTELMACHINES (ELEKTRONISCH)

AFBEELDING:	ART. NR.:	OMSCHRIJVING:
	BI996-X	<p><b>DEZMO</b></p> <p>De <b>professionele</b> machine voor <b>cilinder- en autosleutels</b> op code.</p> <p>De sleutels zijn direct op code te maken of eerst te decoderen en dan volgens fabriekswaarden te frezen. Krachtige motor voor een snel en goed eindresultaat. Standaard wordt de machine geleverd met een console waar alle software op is geïnstalleerd</p>
	BI996	<p><b>DEZMO OPEN</b></p> <p>Als de DEZMO (BI996-X) maar dan van een elektro magnetische spanklem. Hierdoor is de machine later uit te breiden met een DROMO (automatische sleutelaanvoer)</p>
	BI996-ADV	<p><b>DEZMO ADVANCED</b></p> <p>Als de Dezmo-Open maar dan inclusief een automatische sleutelaanvoer (DROMO). Voor deze sleutelaanvoer is geen perslucht nodig, het werkt geheel elektronisch. Inclusief een universeel magazijn voor ca. 50 sleutels</p>
	BI992-IR	<p><b>VERSA</b></p> <p>Een <b>professionele</b> machine voor <b>banen - en boringsleutels</b> op code.</p> <p>De sleutels zijn direct op code te maken of eerst te decoderen en dan volgens fabriekswaarden te frezen. Krachtige motor voor een snel en goed eindresultaat. Standaard wordt de machine geleverd met een console waar alle software op is geïnstalleerd</p>



## SLEUTELMACHINES (ELEKTRONISCH)

AFBEELDING:	ART. NR.:	OMSCHRIJVING:
	BI-SIGMA	<p><b>SIGMA PRO</b></p> <p>Een <b>professionele</b> machine voor het maken van <b>baard- en kluis sleutels</b> op code. Door de krachtige motor worden de sleutels snel en secuur gemaakt. U kunt de sleutel decoderen (m.b.v. de camera) en maken volgens de originele fabriekswaarden. Standaard wordt de machine geleverd met een console waar alle software op is geïnstalleerd</p>
	BI1000	<p><b>GYMKANA</b></p> <p>De ultieme machine voor de <b>automotive</b> industrie om <b>auto- en banensleutels</b> op code te maken. De sleutel is te decoderen en te maken volgens de originele fabriekswaarden. Standaard wordt de machine geleverd met een console waar alle software op staat geïnstalleerd.</p> <p>Wordt standaard geleverd met een U (universeel) en V (VAG) klem.</p>
	BI1001	<p><b>KEYLINE MESSENGER</b></p> <p>Een compacte en complete sleutelmachine welke geschikt is voor het maken van cilinder-, boring en banen sleutels op code. Werkt op netstroom of op een batterij.</p> <p>Handig voor de elke sleutelmaker onderweg.</p>
	KEYCOIN150	<p><b>KEYCOIN150</b></p> <p>150 Keycoins, te gebruiken voor STAK of het updaten van uw elektronische sleutelmachine(s)</p>
	KEYCOINS 300	<p><b>keycoin 300</b></p> <p>300 Keycoins, te gebruiken voor Stak of het updaten van uw elektronische sleutelmachines</p>

## TRANSPONDERMACHINES

AFBEELDING:	ART. NR.:	OMSCHRIJVING:
	BI884	<p><b>BI884 DECRYPTOR</b> Stand Alone <b>Transpondermachine</b>. In te stellen in de Nederlandse taal. De volgende transpondertypen zijn te dupliceren. Temic ID11&amp; ID12 Megamos ID13 Philips ID33 &amp; ID73 Texas 4C fixed &amp; crypto 4D Philips Crypto ID40 (gedeeltelijk), ID44 (VAG), ID45 en ID46. De Megamos ID48 transponders zijn ook te kopiëren na aanschaf van de TKM-Extreme kit.</p>
	BI884-MINI	<p><b>BI884 MINI</b> Eenvoudig te bedienen <b>transpondermachine</b> via een app of via de PC. In te stellen in de Nederlandse taal. De volgende transpondertypen zijn te dupliceren. Temic ID11&amp; ID12 Megamos ID13 Philips ID33 &amp; ID73 Texas 4C fixed &amp; crypto 4D Philips Crypto ID40 (gedeeltelijk), ID44 (VAG), ID45 en ID46. De Megamos ID48 transponders zijn ook te kopiëren na aanschaf van de TKM-Extreme kit.</p>
	TKM-EXTREME-KIT	<p><b>TKM EXTREME KIT</b> Voor de BI884 en de BI884MINI om de ID48 transponders te kunnen clonen.</p>
	EPROM-KIT	<p><b>EEPROM EXTRA</b> Als bij een auto alle sleutels zijn verdwenen, dan is het mogelijk om (bij een groot aantal automodellen) de data uit de Eeprom te halen en deze m.b.v. de BI884 Decryptor of de 884 Mini weer naar een Keyline transponder te schrijven.</p>

## TRANSPONDERMACHINES

AFBEELDING:	ART. NR.:	OMSCHRIJVING:
	<p>BTP2.0-884-MINI</p>	<p><b>BLEUTOOTH EN POWER ADAPTER</b>                      Voor de BI884MINI, deze is geschikt voor IOS en Android</p>
	<p>MAVIK_433</p>	<p><b>MAVIK</b>                      Universele afstandsbediening die dezelfde functionaliteit heeft als de originele autosleutel. Deze afstandsbediening heeft een geïntegreerde transponder en is eindeloos herbruikbaar. De Mavik is ook te programmeren op de meeste automerken en de applicatielijst wordt voortdurend uitgebreid. Precoderen is mogelijk met de 884Mini</p>
	<p>BI803-T-BS</p>	<p><b>STAK</b>                      Met de STAK software is het mogelijk om autosleutels en afstandsbedieningen te programmeren in de auto zelf. Keyline maakt gebruik van de Abrites technologie waardoor top kwaliteit software wordt gegarandeerd.</p>
	<p>IM508</p>	<p><b>IM508</b>                      De Autel IM508 is een professioneel diagnostisch systeem met waarmee het mogelijk is om autosleutels met afstandsbedieningen te programmeren in de auto. Werkt zonder Tokens.</p>
		<p>De IM508 is voorzien van een Nederlandse ondersteuning.</p>

## TRANSPONDERMACHINES

AFBEELDING:	ART. NR.:	OMSCHRIJVING:
-------------	-----------	---------------



IM608

### Autel IM608

De Autel IM608 is diagnostisch uitlees apparaat en door zijn uitgebreide en snelle processor zeer geschikt voor het programmeren van de autosleutels en afstandsbedieningen.

De IM608 zit verpakt in een koffer en er is tevens voorzien van een XP400 (Mercedes sleutels programmeren in de auto) en de G-box (Lost Keys functie voor Mercedes) De IM608 werkt niet met tokens en wordt ondersteunt met de Nederlandse taal.



XP400

### XP400

De XP400 is een uitbreiding op de IM508 en IM608, waarmee verschillende IMMO functies uitgevoerd kan worden o.a. het programmeren van de Mercedes-Benz autosleutels met afstandsbedieningen.



G-BOX

### G-BOX

De G-Box is en uitbreiding op de IM508 en de IM608.

De G-box is geschikt om o.a. de All Keys Lost van de Mercede-Benz on the Bench (uit de wagen gedemonteerd) te programmeren.



APB112

### APB112

SMART KEY SIMULATOR: Is geschikt voor de IM508 en de IM608

De APB112 verzameld gegevens uit de auto Toyota en Lexus met een 46 transponder om zo sleutels bij te maken, mochten er geen sleutels meer bij het voertuig zijn.(o.a. Lost keys).

## TRANSPONDERMACHINES

AFBEELDING:	ART. NR.:	OMSCHRIJVING:
-------------	-----------	---------------



8A  
BLADE KIT

### TOYOTA 8A BLADE AKL KIT

Kabels voor de IM508 en IM608 voor de lost key van Toyota, Lexus en Scion.

Samen te gebruiken met de APB112 en G-Box



IMKPA

### IMKPA

Autel IMKPA Kit bevat 12 adapters, compatibel met de XP400 Pro om de sleutelprogrammering van de XP400 Pro uit te breiden.

Kit bevat: APB113, APB114, APB115, APB118, APB119, APB120, APB121, APB122, APB123, APB126, APB127, APB128.



Autel-  
Renault  
P001

### Autel adapter voor Renault.

Met deze adapter is het mogelijk om de autosleutels te programmeren met de IM508 en IM608 voor de volgende typen

**Talisman**  
**Megane 4**  
**Clio 5**  
**Scenic 4**  
**Espace 5**

## TRANSPONDERMACHINES

AFBEELDING:	ART. NR.:	OMSCHRIJVING:
-------------	-----------	---------------

De VMAX en VMINI zijn geschikt voor het detecteren, bewerken en de frequentie te meten van een transponder of afstandsbediening.



VMAX

### VMAX

Met de V-Max is het mogelijk om diverse transpondertypen te clonen naar de Super chip.

Tevens is de VMAX geschikt om de XHorse sleutels en Super chip te genereren naar verschillende OEM autosleutels.

Als een remote en/of Super chip is gegenereerd dan kun je deze in de auto inleren met Autel of een ander diagnostisch apparaat.



VMINI

### VMINI

De VVDI mini is een kleine machine die gekoppeld moet worden aan een smartphone. Het mogelijk om diverse transpondertypen te clonen naar de Super chip.

Deze VMINI is d.m.v. een app ook geschikt voor het genereren van verschillende OEM autosleutels.







XDKP30GL

### XDKP30GL

Multifunctionele adapter van Xhorse

## TRANSPONDERMACHINES

AFBEELDING:	ART. NR.:	OMSCHRIJVING:
	XDNA12	<p><b>XDNA12</b>                      Soldeeradapter BMW CAS4 / CAS4+ van Xhorse</p>
	VVDI PROG EZS	<p><b>VVDI PROG EZS ADAPTER EIS</b>                      Adapters Voor Mercedes Benz W164 W169                      W203 W209 W211 W215 W639</p> <p>Volledige kit van 10 stuks, werkt met VVDI                      Prog.</p>
	X-CUT	<p><b>X-CUT</b></p> <p>De X-cut is een banenfreesmachine die geschikt is voor het maken van speciale sleutelprofielen.</p> <p>Sleutels in verschillende uitvoeringen en maten verkrijgbaar</p>
	MH-AX-CUT	Frees voor de X-Cut machine



## TRANSPONDERMACHINES

AFBEELDING:	ART. NR.:	OMSCHRIJVING:
	A90+	<p><b>AK90+</b> AUTO KEY PROGRAMMER</p>
	MERCEDES BENZ PROGRAM MER	MERCEDES BENZ PROGRAMMER
	OPZ11619B / C10PUNZONE	<p><b>MARCATOR</b> Een houder en losse stempel om uw naam in de sleutels te slaan d.m.v. een rubberen hamer</p>





## FREZEN EN ADAPTERS

## MACHINE TOEBEHOREN

AFBEELDING:	ART. NR.:	OMSCHRIJVING:
-------------	-----------	---------------

### BORSTEL

AFBEELDING:

ART. NR.:

OMSCHRIJVING:



RIC04636B

KUNSTSTOF AFBRAAMBORSTEL 80x15x10  
VOOR DE CARAT / BRAVO

### FREZEN EN TASTERS



MH01

METAFA HSS PRISMA FREES 80x5x16  
VOOR DE CARAT / BRAVO



MH01W

METAFA WIDIA PRISMA FREES 80x5x16  
VOOR DE CARAT / BRAVO









RIC01720B

FREES HSS HPP01 80X5X16 84°,  
CARAT

## MACHINE TOEBEHOREN

AFBEELDING:	ART. NR.:	OMSCHRIJVING:
	RIC01717B	WIDIA FREES WPP0 1 80X5X16 84°, CARAT
	RIC04638B	TASTER VOOR DE KEYLINE CARAT
	D906603ZR	TASTER VOOR SILCA BRAVO PROFESSIONAL
	RIC01777B	FREES HSS-HB012A-D6-30°-100°-P.0,6 T-REX, T-REX ADV., PUNTO
	RIC01778B	TASTER B012A D6 30° 100° P.0,6, T-REX, T-REX ADV., PUNTO
	RIC01779B	FREES HSS-HB012B-D6-96°-P.2-2,8 - T-REX, T-REX ADV., PUNTO
	RIC01780B	TASTER B012B D8 94° P.2-2,8, T-REX, T-REX ADV., PUNTO







## MACHINE TOEBEHOREN

AFBEELDING:	ART. NR.:	OMSCHRIJVING:
	RIC01781B	FREES HSS HB015 D8 90° P.0,8 T-REX, T-REX ADV., PUNTO
	RIC01782B	TASTER B015 D6 88° P.0,8 T-REX, T-REX ADV., PUNTO
	RIC01785B	FREES HSS HB039 D6 90° P.0,6 T-REX, T-REX ADV., PUNTO
	RIC01786B	TASTER B039 D6 88° P.0,6 T-REX, T-REX ADV., PUNTO
	RIC01789B	FREES HB042 D6 100° P.0,7 T-REX, T-REX ADV., PUNTO
	RIC01790B	TASTER B042 D6 98° P.0,7 T-REX, T-REX ADV., PUNTO
	RIC01791B	FREES HSS HB001 D6 90° P.0,7 T-REX, T-REX ADV., PUNTO
	RIC01792B	TASTER B001 D.6 P.0,70 T-REX, T-REX ADV., PUNTO
	RIC01793B	FREES HSS HB020 D.6 P.0.45 T-REX, T-REX ADV., PUNTO

## MACHINE TOEBEHOREN

AFBEELDING:	ART. NR.:	OMSCHRIJVING:
	RIC01794B	TASTER B020 D.6 P.0.45, T-REX, T-REX ADV., PUNTO
	RIC01810B	FREES 2 EL. ZIJDEN HSS HC011 D.2,5MM, T-REX, T-REX ADV., PUNTO
	RIC01811B	TASTER C011 2.5MM T-REX, T-REX ADV., PUNTO
	RIC01812B	FREES 2 ZIJDEN EL.HSS HC023 D.1,5MM T5 T-REX, T-REX ADV., PUNTO
	RIC01813B	TASTER C023 D.6 D.1,5 T-REX, T-REX ADV., PUNTO
	RIC01816B	FREES 2 ZIJDEN EL.HSS-HC044-D.2mm-T.6 T-REX, T-REX ADV., PUNTO
	RIC01817B	TASTER C044 D.2MM T-REX, T-REX ADV., PUNTO
	RIC01820B	FREES 2 ZIJDEN HSS HC003 D.1,5MM T.0,9 T-REX, T-REX ADV., PUNTO
	RIC01813B	TASTER C003 D.1,5MM T-REX, T-REX ADV., PUNTO









## MACHINE TOEBEHOREN

AFBEELDING:	ART. NR.:	OMSCHRIJVING:
	RIC01857B	KLAVIERFREES 80X22X1 ( DIKTE 1 MM)
	RIC01858B	KLAVIERFREES 80X22X15 ( DIKTE 1,5 MM)
	RIC02865B	FREES WSSG36 Ø100X1.25X22 SIGMA PRO
	V001F	METAFRA FREES V001, VERSA, NINJA VORTEX, NINJA TOTAL
	RIC05044B	FREES V001, VERSA, NINJA VORTEX, NINJA TOTAL
	V003F	METAFRA FREES V003 Ø2,5MM VERSA, NINJA VORTEX, NINJA TOTAL
	RIC05048B	FREES V003 Ø2,5MM VERSA, NINJA VORTEX, NINJA TOTAL
	V000F	METAFRA V000 GRAVERFREES NINJA TOTAL, VERSA
	RIC05050B	V000 GRAVERFREES NINJA TOTAL, VERSA

## MACHINE TOEBEHOREN

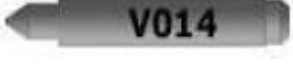
AFBEELDING:	ART. NR.:	OMSCHRIJVING:
	V004F	METAFa FREES V004 VERSA, NINJA VORTEX, NINJA TOTAL
	RIC05084B	FREES V004 VERSA, NINJA VORTEX, NINJA TOTAL
	V007F	METAFa FREES V007 VERSA, NINJA VORTEX, NINJA TOTAL
	RIC05264B	FREES V007 VERSA, NINJA VORTEX, NINJA TOTAL
	V008F	METAFa FREES V008 VERSA, NINJA VORTEX, NINJA TOTAL
	RIC05266B	FREES V008 VERSA, NINJA VORTEX, NINJA TOTAL
	WC011A	METAFa FREES 3 T.EL WC011A D.2,5MM T.3,5 994 LASER
	RIC05304B	FREES 3 T.EL WC011A D.2,5MM T.3,5 994 LASER
	RIC05274B	KOFFER VOOR DE EXPERT MET OPENSTEEKGEREEDSCHAPPEN. DEZE IS VOORZIEN VAN 2 KNAKKERS, 3 X 10 STUKS VERSCHILLENDE MATEN TREKSCROEVEN. KERNTREKBEVEILIGING-

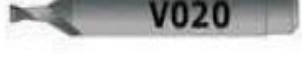
## MACHINE TOEBEHOREN

AFBEELDING:	ART. NR.:	OMSCHRIJVING:
	RIC05348B	CILINDRISCHE TASTER ( VOOR TASTERBRUG ) VERSA, NINJA VORTEX, NINJA TOTAL
	RIC05352B	CONISCHE TASTER ( VOOR TASTERBRUG ) VERSA, NINJA VORTEX, NINJA TOTAL
	V013F	METAFA FREES V013 VERSA, NINJA VORTEX, NINJA TOTAL
	RIC05618B	FREES V013 VERSA, NINJA VORTEX, NINJA TOTAL
	RIC05612B	FREES V014 VERSA, NINJA VORTEX, NINJA TOTAL
	RIC05506B	FREES V016 VERSA, NINJA VORTEX, NINJA TOTAL
	V020F	METAFA FREES V020 Ø1,28MM VERSA, NINJA VORTEX, NINJA TOTAL
	RIC06102B	FREES V020 Ø1,28MM VERSA, NINJA VORTEX, NINJA TOTAL
	RIC06368B	FREES V022 VERSA, NINJA VORTEX, NINJA TOTAL



## MACHINE TOEBEHOREN







AFBEELDING:	ART. NR.:	OMSCHRIJVING:
	V030F	METAFA FREES V030 (LIPS OCTRO) VERSA, NINJA VORTEX, NINJA TOTAL
	V044F	METAFA FREES V044 VERSA, NINJA VORTEX, NINJA TOTAL
	RIC09442B	FREES V044 VERSA, NINJA VORTEX, NINJA TOTAL
	RIC10801B	FREES V053 (DOM TECO) VERSA, NINJA VORTEX, NINJA TOTAL
	RIC09902B	DIAMANT FREES NINJA VORTEX
	RIC09483B	DECODEER TASTER TL003 D. 1,5 MM 994LA, NINJA LASER
	RIC11110B	TASTER T08 1 MM VOOR GYMKANA
	MHDEZ1	METAFA FREES WIDIA F01 D.80X16X5-80° DEZMO

## MACHINE TOEBEHOREN







AFBEELDING:	ART. NR.:	OMSCHRIJVING:
	RIC08143B	FREES WIDIA F01 D.80X16X5-80° DEZMO
	RIC08213B	FREES F02, D80x16x5 80 graden DEZMO
	MHNIN	METAFA PRISMA FREES, WP034, D63x16x5 NINJA, NINJA TOTAL, NINJA LASER.
	RIC09168B	PRISMA FREES, WP034, D63x16x5 NINJA, NINJA TOTAL, NINJA LASER.
	U01W	METAFA WIDIA FREES SILCA UNOCODE

## MACHINE TOEBEHOREN

### ADAPTERS / KLEMMEN

AFBEELDING:	ART. NR.:	OMSCHRIJVING:
	MM	ADAPTER VOOR MERCEDES T-REX, PUNTO
	MOMAX	ADAPTER VOOR FORD C-MAX / GM T-REX, PUNTO
	OPZ04403B	ADAPTER VOOR PIJPSLEUTELS, SIGMA
	OPZ06511B	ADAPTER AV06 VOOR AXA SLEUTELS (AXA1P, AXA1BP) VERSA, NINJA LASER, NINJA TOTAL
	OPZ08843B	ADAPTER AV07 VOOR KLEM C01 / C30 VOOR EVVA 3KS SLEUTELS VERSA, NINJA VORTEX, NINJA TOTAL
	RIC05196B	AFSTELPLAATJES BI106 / CARAT

## MACHINE TOEBEHOREN

AFBEELDING:	ART. NR.:	OMSCHRIJVING:
	RIC04660B	STANDAARD KLEMSET VOOR BI106 / CARAT
	OPZ04873B	KLEM A02 AUTOSLEUTELS, NINJA TOTAL, NINJA VORTEX, VERSA
	OPZ04875B	KLEM A03 AUTOSLEUTELS NINJA TOTAL, NINJA VORTEX, VERSA
	OPZ04877B	KLEM A04 MERCEDES NINJA TOTAL, NINJA VORTEX, VERSA
	OPZ04879B	STANDAARD KLEM C01 (EERSTE GENERATIE) NINJA VORTEX, VERSA
	OPZ04971B	TASTERBLOK KESO MULTICODE VERSA

## MACHINE TOEBEHOREN

AFBEELDING:	ART. NR.:	OMSCHRIJVING:
	OPZ05033B	KLEM 06 VOOR DIKKE BAARDSLEUTELS SIGMA PRO, BI993 POWER LYNX
	OPZ06711B	KLEM C011 LIPS KESO VERSA, NINJA TOTAL, NINJA VORTEX
	OPZ09335B	GRAVEERKLEM C25 VERSA, NINJA TOTAL
	OPZ09531B	KLEM N25 VOOR PFAFFENHAIN. DEZMO, NINJA, NINJA DARK, NINJA TOTAL
	OPZ10611B	KLEM C43 (M&C) NINJA TOTAL, NINJA VORTEX, VERSA
	OPZ10826B	KLEM C46 NINJA LASER, NINJA VORTEX, NINJA TOTAL, VERSA

## MACHINE TOEBEHOREN

AFBEELDING:	ART. NR.:	OMSCHRIJVING:
	OPZ10976B	KLEM C52 (M&C) NINJA, VERSA
	RIC01679B	VERVANGKLEMMEN FREESZIJD T-REX
	RIC01678B	VERVANGKLEMMEN TASTERZIJD T-REX
	OPZ09508B	COMPLETE LAMPSET, INCLUSIEF SCHAKELAAR B1106 / CARAT
	OPZ11120B	ARM SUPPORT NINJA
	RIC01745B	Lamp 15W PUNTO

## MACHINE TOEBEHOREN





AFBEELDING:	ART. NR.:	OMSCHRIJVING:
	RIC01748B	HOOFDSCHAKELAAR CARAT, NINJA, DEZMO, VERSA
	RIC02141B	SCHAKELAAR BESCHERMHOES FALCON, ARCADIA, NINJA, T-REX, CARAT, DEZMO, VERSA
	RIC04650B	RIEM BI106 / CARAT
	RIC04670B	WAGENVEER BI106 / CARAT
	RIC04678B	SLEUTELAANSLAG 2 STUKS CARAT / BI106
	RIC04960B	RIEM SIGMA PRO
	RIC05658B	WAGEN ONTGRENDELINGSVEER BI106 / CARAT

## MACHINE TOEBEHOREN

AFBEELDING:	ART. NR.:	OMSCHRIJVING:
	RIC06156B	FREES RIEM VERSA
	RIC06570B	NOODKNOP NINJA, DEZMO, SIGMA PRO,
	RIC06712B	KLEMVEER BI106 / CARAT
	RIC07642B	MONITOR V4 XENARC 7 INCH TOUCH SCREEN DEZMO, VERSA, SIGMA PRO
	RIC08007B	KLEM GREEP - GRIJS/ROOD BI106/CARAT, NINJA, DEZMO
	RIC08307B	SPINDELRIEM PUNTO



## MACHINE TOEBEHOREN

AFBEELDING:	ART. NR.:	OMSCHRIJVING:
	RIC09671B	KUNSTSTOF BESCHERMKAP NINJA, NINJA LASER, NINJA VORTEX, NINJA TOTAL
	RIC09700B	SENSOR X- EN Y-AS NINJA
	RIC09953B	RIEM 330x10 NINJA TOTAL, NINJA VORTEX
	RIC10005B	RIEM 230x10 NINJA LASER
	RIC10170B	V-SNAAR T-REX



**Metafa Holland B.V.**

Metafa Holland bv  
Ekkersrijt 1305  
5692 AJ Son  
085-02991536

e-mail: [info@metafa.nl](mailto:info@metafa.nl)  
[www.metafa.nl](http://www.metafa.nl)  
[www.webshop.metafa.nl](http://www.webshop.metafa.nl)  
BTW-nr. NL 860668022B01

©2023-06 Metafa Holland B.V.

Alle rechten voorbehouden. Niets van deze uitgave mag worden verveelvoudigd, gekopieerd of openbaar gemaakt in enige vorm of op enige wijze, zonder voorafgaande schriftelijke toestemming van Metafa Holland B.V. tenzij anders overeengekomen.